



DENO-00317

DENON

Hi-Fi Component

SERVICE MANUAL

MODEL POA-T2/T3 MODEL POA-3200

STEREO POWER AMPLIFIER

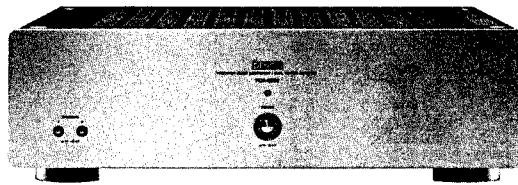

POA-3200

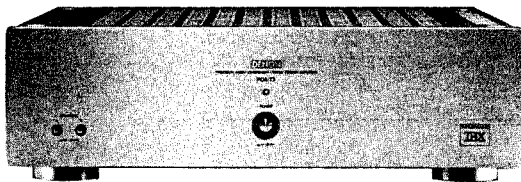

POA-T2

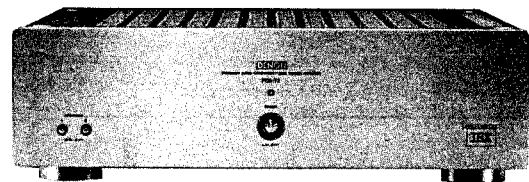

POA-T3

— TABLE OF CONTENTS —

| | |
|---|-------|
| OPERATING INSTRUCTIONS (POA-T2/T3) | 2-5 |
| OPERATING INSTRUCTIONS (POA-3200) | 6-11 |
| DISASSEMBLY | 12-15 |
| BLOCK DIAGRAM | 16 |
| METHOD OF ADJUSTMENT | 17 |
| SEMICONDUCTORS | 18 |
| NOTE FOR PARTS LIST | 19 |
| PARTS LIST OF PRINTED WIRING BOARD | 20,21 |
| PARTS LIST OF EXPLODED VIEW (POA-T3) | 22 |
| EXPLODED VIEW (POA-T3) | 23 |
| PARTS LIST OF EXPLODED VIEW (POA-T2/3200) | 24 |
| EXPLODED VIEW (POA-T2/3200) | 25 |
| PRINTED WIRING BOARD | 26,27 |
| WIRING DIAGRAM | 28 |
| SCHEMATIC DIAGRAM | 29 |

NIPPON COLUMBIA CO., LTD.



CAUTION
RISK OF ELECTRIC SHOCK
DO NOT OPEN

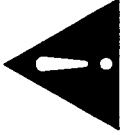

CAUTION: TO REDUCE THE RISK OF ELECTRIC SHOCK, DO NOT REMOVE COVER (OR BACK). NO USER SERVICEABLE PARTS INSIDE. REFER SERVICING TO QUALIFIED SERVICE PERSONNEL.

The lightning flash with arrowhead symbol, within an equilateral triangle, is intended to alert the user to the presence of uninsulated "dangerous voltage" within the product's enclosure that may be of sufficient magnitude to constitute a risk of electric shock to persons.

The exclamation point within an equilateral triangle is intended to alert the user to the presence of important operating and maintenance (servicing) instructions in the literature accompanying the appliance.

WARNING: TO REDUCE THE RISK OF FIRE OR ELECTRIC SHOCK, DO NOT EXPOSE THIS APPLIANCE TO RAIN OR MOISTURE.

安全注意事項



CAUTION
RISK OF ELECTRIC SHOCK
DO NOT OPEN







注意：為減少觸電危險，切勿拆下機殼（或機背）。機身內並無用戶修理用零件。請交由專業修理人員修理本機。

三角形內有箭頭的閃電符號旨在提醒用戶，本產品機殼內有未經絕緣的“危險電壓”，其幅度足以使人觸電而發生危險。

三角形內加感嘆符號旨在提醒用戶，有重要的操作與維修說明書配合本機。

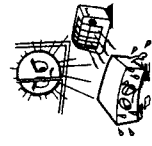
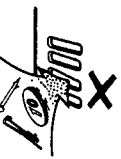
警告：為減少着火或觸電危險，切勿讓本機受雨淋濕或受潮。

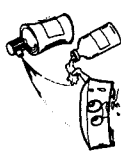
NOTE ON USE

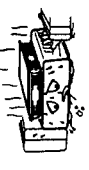
| | |
|---|---|
|  |  |
| <ul style="list-style-type: none"> Avoid high temperatures. Allow for sufficient heat dispersion when installed on a rack. | <ul style="list-style-type: none"> Do not let foreign objects in the set. |
|  |  |
| <ul style="list-style-type: none"> Unplug the power cord when not using the set for long periods of time. | <ul style="list-style-type: none"> Do not let insecticides, benzene, and thinner come in contact with the set. |
|  |  |
| <ul style="list-style-type: none"> Handle the power cord carefully. Hold the plug when unplugging the cord. | <ul style="list-style-type: none"> Never disassemble or modify the set in any way. |
|  | |
| <ul style="list-style-type: none"> Do not obstruct the ventilation holes. | |

Please check to make sure the following items are included with the main unit in the carton:

- (1) Operating Instructions 1
- (2) Remote Power Cord 1
- (3) AC Power Cord 1

NOTE:

1. Always keep the POWER switch on the main unit turned on.
2. Turn the power on and off from the remote control unit of the pre-amplifier (AVP-A1, etc).
3. Unplug the power cord when you do not plan to use the unit for a long period of time.

PRECAUTIONS FOR INSTALLATION

Leave at least 10cm of space between this unit and any other component placed above.

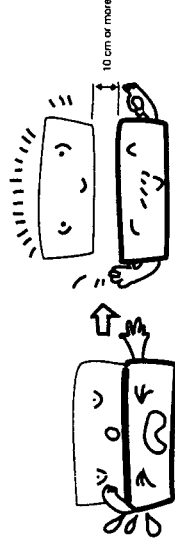

FRONT PANEL

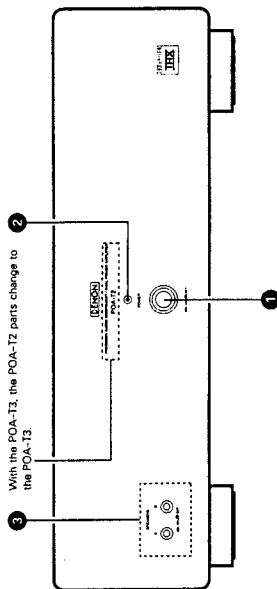

NAMES AND FUNCTIONS OF PARTS

- 1 Power switch (POWER)**
When this switch is pressed, the power is turned on, the POWER indicator (2) flashes for some seconds and then lights steadily, and stable operation condition is reached. When this switch is pressed again, the power is turned off.
- 2 Power indicator**
This lights orange when the power is on, and turns red when the power is turned off with remote terminal (5).
- 3 Speaker selector buttons (SPEAKERS)**
When button A is set to the "ON ()" position, sound is produced from the speaker systems connected to the "A" speaker terminals.
When button B is set to the "ON ()" position, sound is produced from the speaker systems connected to the "B" speaker terminals.
When both the A and B buttons are set to the "ON ()" position, sound is produced from the speaker systems connected to both the "A" and "B" speaker terminals.
When both the A and B buttons are set to the "OFF ()" position, no sound is produced from the speaker systems. Use this when listening over headphones.
- 4 Speaker System terminal (SPEAKER SYSTEMS)**
Connect the speaker systems here.
- 5 Remote terminal (REMOTE ON-OFF)**
This terminal is used for remote control of the pre-amplifier. A low-voltage DC current is emitted from the terminal to turn on the power of a DENON pre-amplifier.
The main unit's power can be turned on and off with the pre-amplifier's remote control unit when the pre-amplifier and main unit's input terminal are connected with the included cable. When the main unit's output terminal is connected to the input terminal of another power amplifier, the other power amplifier's power can be turned on and off.
- 6 AC IN**
Connect this to a power outlet using the included AC power cord.
- 7 Input terminal (INPUT)**
This is an input terminal (RCA connector). Connect it to the pre-amplifier's pre-out terminal.

PROTECTOR

Various protector circuits are included in this unit. The output is interrupted in the following case:

- (1) Muting time, which lasts for several seconds after the power is turned "on".
- (2) When the offset voltage of the power amplifier has drifted outside the prescribed range.
- (3) When the temperature of the power amplifier is abnormally high.
- (4) When a speaker terminal is shorted or a speaker's impedance is extremely low.

This set is equipped with a heat-dispersing motor fan. The motor fan operates when it senses that the temperature inside the set is high and the heat must be dispersed.

REAR PANEL

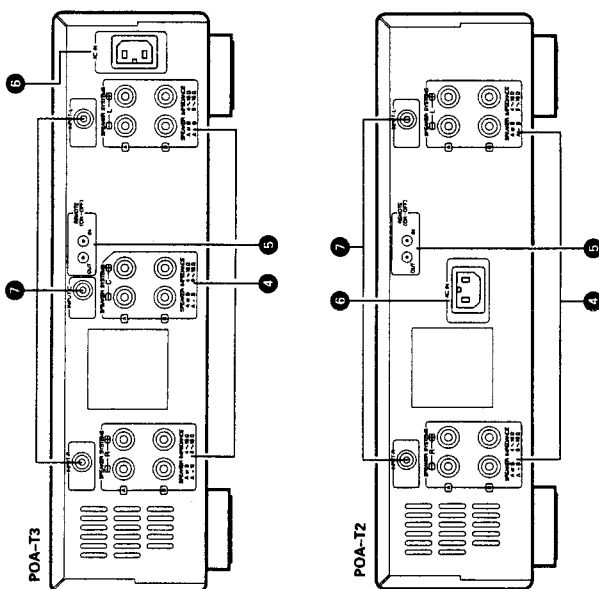

Manufactured under license from Lucasfilm Ltd. Lucasfilm and THX are registered trademarks of Lucasfilm Ltd.

CONNECTIONS

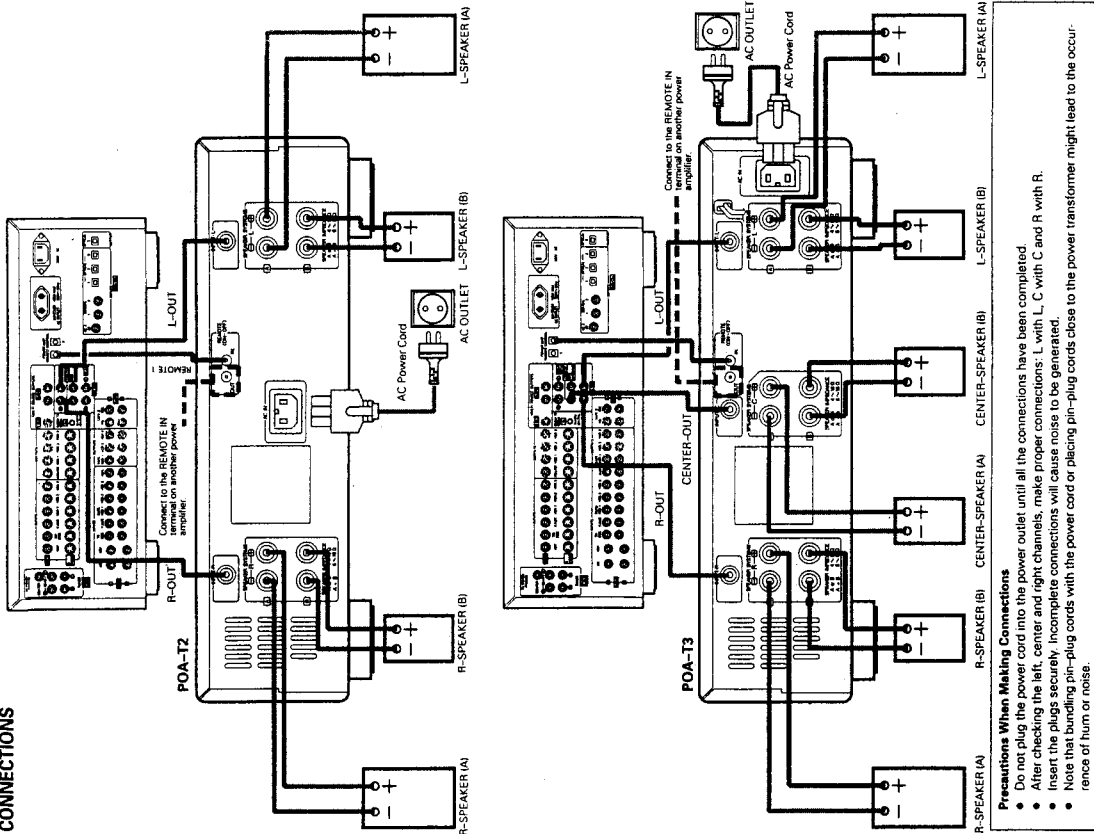

Precautions When Making Connections

- Do not plug the power cord into the power outlet until all the connections have been completed.
- After checking the left, center and right channels, make proper connections: L with L, C with C and R with R.
- Insert the plugs securely. Incomplete connections will cause noise to be generated.
- Note that bundling pin-plug cords with the power cord or placing pin-plug cords close to the power transformer might lead to the occurrence of hum or noise.

- **Connection to the speaker system**
 - When connecting the speaker terminals to the speaker systems, make certain to connect the polarities correctly (+ to + and - to -). If the polarities are incorrect when the two are connected, the center area of the sound will be lacking, the positions of the musical instruments will not be clear, and the stereo directional sensitivity will be impaired.
 - During connection, be careful that the center wires in the speaker cords do not protrude from the terminals to contact any other terminal, and that the central wires in the separate speaker cords do not contact each other.

- **Speaker impedance**
 - When only one of the A or B terminals is used, the speakers that are to be connected should have a nominal impedance of 4 to 16 Ω /ohms.
 - When the two sets (A + B) are to be used at the same time, use of speakers whose impedance is outside the range from 8 to 16 Ω /ohms will result in malfunction. Be careful not to let this happen.
 - Speakers with a lower impedance may cause the protective circuitry to operate.

SPECIFICATIONS

| | | | |
|---|----------------|---|--------------------------------|
| Rated Output Power: (8 Ω /ohms Load) 20 Hz to 20 kHz, T.H.D. 0.02% (4 Ω /ohms Load) 1 kHz, T.H.D. 0.5% | 120 W 200 W | Input Impedance: Normal in: | 47 k Ω /kohms |
| Total Harmonic Distortion: (-3 dB at rated output, 8 Ω /ohms) (20 Hz to 20 kHz) | 0.008% | Output Impedance: | 0.1 Ω /ohms (1 kHz) |
| Intermodulation Distortion: (60 Hz/7 kHz: 4/1 at rated output, 8 Ω /ohms) | 0.002% | S/N Ratio: (IHF, A-weighting) (Normal) | 110 dB |
| Power Band Width: (8 Ω /ohms, THD 0.05%) | 5 Hz - 50 kHz | Output Terminals: Speakers A or B 4 Ω /ohms - 16 Ω /ohms A + B 8 Ω /ohms - 16 Ω /ohms | |
| Frequency Response: +0, -3 dB (at 1 W) | 1 Hz - 100 kHz | Power Supply: | AC 230 V/50 Hz |
| Input Sensitivity: Normal in: | 1.1 V | Power Consumption: | POA-T3 470 W POA-T2 330 W |
| | | Dimensions: (Including control knobs and feet) | 434 (W) x 135 (H) x 353 (D)mm |
| | | Weight: | POA-T3 16 kg POA-T2 12.3 kg |

- Specifications and contents are subject to change without notice for purposes of improvement.

TROUBLESHOOTING

Before troubleshooting, be sure to check whether your audio system is really the source of the problem.

If you think the amplifier is out of order, first check the following one more time:

1. Are all the connections correctly made?
 2. Is the set being operated properly in accordance with the Operating Manual?
 3. Are the speakers and pre-amplifier being operated correctly?
- If the set does not operate properly, perform the checks indicated in the flow chart below. Turn off the power immediately, and contact the outlet where you purchased the amplifier or your nearest DENON dealer.

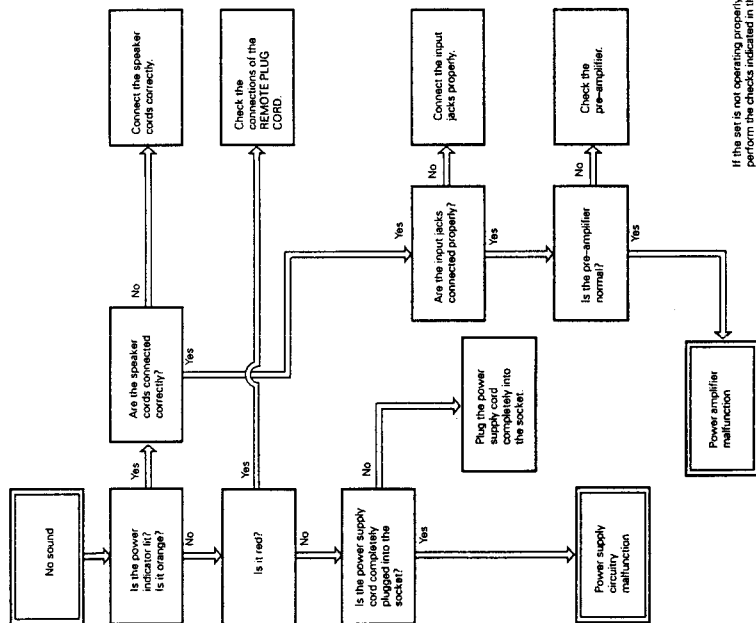

If the set is not operating properly, perform the checks indicated in this flow chart.

NOTE:
 1. Always keep the POWER switch on the main unit turned on.
 2. Turn the power on and off from the remote control unit of the pre-amplifier (PPA-S10, etc.).
 3. Unplug the power cord when you do not plan to use the unit for a long period of time.

CAUTION:
 If only the STANDBY indicator is lit, this means that the power is turned off from the remote control unit. Turn the power on from the remote control unit of the pre-amplifier (PPA-S10, etc.).

HINWEIS:
 1. Lassen Sie den Netzschalter (POWER) am Hauptgerät stets eingeschaltet.
 2. Schalten Sie den Strom mit Hilfe des Fernbedienungsgerätes des Vorverstärkers (PPA-S10 o.ä.) ein und aus.
 3. Trennen Sie das Netzkabel vom Netz ab, wenn Sie beabsichtigen, das Gerät über einen längeren Zeitraum hinweg nicht zu benutzen.

VORSICHT:
 Wenn die STANDBY-Anzeige leuchtet, bedeutet dies, dass der Strom mit dem Fernbedienungsgerät ausgeschaltet worden ist. Schalten Sie den Strom mit dem Fernbedienungsgerät des Vorverstärkers (PPA-S10 usw.) ein.

REMARQUE:
 1. S'assurer que le commutateur d'alimentation (POWER) sur l'unité principale reste toujours allumé.
 2. Allumer et éteindre l'appareil avec le télécommande du préamplificateur (PPA-S10, etc.).
 3. Débrancher le cordon d'alimentation lorsque l'appareil ne sera pas utilisé pendant une longue période.

ATTENTION:
 Se solamente l'indicatore STANDBY (attesa) è illuminato, ciò significa che la corrente è stata spenta usando il telecomando del preamplificatore (PPA-S10, etc.).

NOTA:
 1. Tenete sempre l'interruttore della corrente (POWER) dell'unità principale nella posizione di attivazione.
 2. Spegnete e accendete la corrente usando il telecomando del preamplificatore (PPA-S10, etc.).
 3. Scollegate il filo di alimentazione quando avete intenzione di non usare l'apparecchio per un lungo periodo.

AVISO:
 Se solo l'indicatore STANDBY (attesa) está iluminado, ciò significa que la corriente está apagada usando el telecomando del preamplificador (PPA-S10, etc.).

PRECAUTIONS FOR INSTALLATION
 Leave at least 10 cm of space between this unit and any other component placed above.

SICHERHEITSMASSNAHMEN BEIM EINBAU
 Lassen einen Mindestabstand von 10 cm zwischen diesem Gerät und der anderen Komponente, die daraufgestellt wird.

PRECAUTIONS D'INSTALLATION
 Prévoir un espace d'au moins 10 cm entre l'unité et tout autre appareil se trouvant au-dessus.

PRECAUTIONI PER L'INSTALLAZIONE
 Lasciate uno spazio libero di almeno 10 cm tra quest'unità e qualsiasi altro componente che è collocato sopra la stessa.

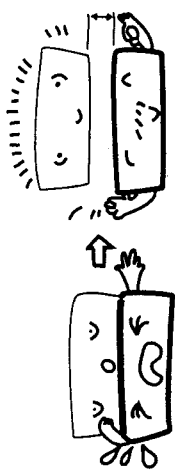

NOTE:
 1. Mantenga siempre activado el interruptor de alimentación (POWER) en la unidad principal.
 2. Conecte y desconecte la alimentación mediante la unidad de control remoto del preamplificador (PPA-S10, etc.).
 3. Cuando la unidad vaya a estar fuera de uso por un periodo prolongado de tiempo, desconecte el cable de alimentación.

PRECAUTION:
 Cuando solo el indicador STANDBY (espera) esté encendido, significa que la alimentación ha sido desconectada desde la unidad de control remoto. Conecte la alimentación mediante la unidad de control remoto del preamplificador (PPA-S10, etc.).

OPMERKING:
 Zorg er voor dat de stroomschakelaar (POWER) van het hoofd toestel in de juiste toestand staat.
 2. Schakel de spanning in en uit met de afstandsbediening van de voorversterker (PPA-S10, enz.).
 3. Trek het netkabel uit wanneer u denkt het toestel gedurende een lange periode niet te gebruiken.

WAARSCHUWING:
 Wanneer alleen de STANDBY-indicator brandt, betekent dit dat de spanning is uitgeschakeld met de afstandsbediening. Schakel de spanning in met de afstandsbediening van de voorversterker (PPA-S10, enz.).

OBSERVERA:
 1. Låt alltid strömstyraren (POWER) på huvudenheten vara påslagen.
 2. Sätt strömmen till och från via fjärrkontrollen som medföljer för förstärkaren (PPA-S10 m.fl.).
 3. Koppla loss nätkabeln om apparaten inte skall användas under lång tid.

AVVISO:
 On endast strömstyraren (POWER) på huvudenheten var påslagen.
 2. Sätt strömmen till och från via fjärrkontrollen som medföljer förstärkaren (PPA-S10 m.fl.).
 3. Koppla loss nätkabeln om apparaten inte skall användas under lång tid.

NOTA:
 1. Mantenga o interruptor de Corrente (POWER) na unidade principal sempre ligado.
 2. Ligue e desligue a corrente a partir da unidade de controlo remoto do pré-amplificador (PPA-S10, etc.).
 3. Desconecte o fio de força quando intente não utilizar a unidade por longo tempo.

PRECAUCÃO:
 Se apenas estiver iluminado o indicador de aguardar (STANDBY), isto significa que a corrente está desligada a partir da unidade de controlo remoto. Ligue a corrente a partir da unidade de controlo remoto do pré-amplificador (PPA-S10, etc.).

PRECAUCIONES PARA LA INSTALACION
 Deje por lo menos 10 cm de espacio entre esta unidad y cualquier otro componente situado sobre ella.

VOORZORGSAAMTREGELIEN
 Bij plaatsing dient u een ruimte van minstens 10 cm open te laten tussen het toestel en een ander erop geplaatst component.

FÖRSIKTIGHETSÅTGÄRDER VID INSTALLATIONEN
 Se till att det finns minst 10 cm mellanrum mellan apparaten och en ev. annan apparat som sätts ovanpå.

CUIDADOS NA INSTALAÇÃO
 Deixe um espaço de pelo menos 10 cm entre esta unidade e qualquer outro componente colocada acima.

ENGLISH

Please check to make sure the following items are included with the main unit in the carton:

- (1) Operating Instructions
- (2) Remote Power Cord
- (3) AC Power Cord

DEUTSCH

Bitte überprüfen Sie, ob die folgenden Teile vollständig in der Verpackung enthalten sind:

- (1) Bedienungsanleitung
- (2) Fernbedienungskabel
- (3) AC-Netzkabel

FRANCAIS

Veuillez contrôler que les articles suivants sont bien joints à l'appareil principal dans le carton:

- (1) Mode d'emploi
- (2) Cordon d'alimentation de télécommande
- (3) Cordon électrique AC

ITALIANO

Controllare che le parti seguenti si trovino imballate con l'apparecchio nella scatola di spedizione:

- (1) Libretto delle istruzioni
- (2) Fido di alimentazione a distanza
- (3) Fido di alimentazione CA

ESPAÑOL

Por favor verifique asegurándose de que los siguientes artículos son empacados en la caja pero separados de la unidad principal:

- (1) Manual de instrucciones
- (2) Cable de encendido automático
- (3) Cable de corriente CA

NEDERLANDS

Controleer of de volgende accessoires bij het hoofdtoestel in de doos zijn verpakt:

- (1) Gebruiksaanwijzing
- (2) Afstandsbedieningshoer
- (3) Netkabel

SVENSKA

Kontrollera att följande, förutom huvudapparaten, finns med i kartongen:





- (1) Bruksanvisning
- (2) Kabel för fjärrstyrd strömstyrning
- (3) Nätledad

PORTUGUÊS

Certifique-se de que as seguintes peças estão incluídas na embalagem fora da unidade principal:

- (1) Instruções de operação
- (2) Cabo de Alimentação de Controlo Remoto
- (3) Cabo de CA

NAMES AND FUNCTIONS OF PARTS

- 1 Power switch (POWER)**
When this switch is pressed, the power is turned on, the POWER indicator **2** flashes for some seconds and then lights steadily, and stable operation condition is reached.
When this switch is pressed again, the power is turned off.
- 2 Power indicator**
This lights orange when the power is on, and turns red when the power is turned off with remote terminal **5**.
- 3 Speaker selector buttons (SPEAKERS)**
When button A is set to the "ON ()" position, sound is produced from the speaker systems connected to the "A" - speaker terminals.
When button B is set to the "ON ()" position, sound is produced from the speaker systems connected to the "B" - speaker terminals.
When both the A and B buttons are set to the "ON ()" position, sound is produced from the speaker systems connected to both the "A" and "B" - speaker terminals.
When both the A and B buttons are set to the "OFF ()" position, no sound is produced from the speaker systems. Use this when listening over headphones.
- 4 Speaker System terminal (SPEAKER SYSTEMS)**
Connect the speaker systems here.
- 5 Remote terminal (REMOTE ON-OFF)**
This terminal is used for remote control of the pre-amplifier. A low-voltage DC current is emitted from the terminal to turn on the power of a DENON pre-amplifier.
The main unit's power can be turned on and off with the pre-amplifier's remote control unit when the pre-amplifier and main unit's input terminal are connected with the included cable. When the main unit's output terminal is connected to the input terminal of another power amplifier, the other power amplifier's power can be turned on and off.
- 6 AC IN**
Connect the included AC power cord here.
- 7 Input terminal (INPUT)**
This is a input terminal (RCA connector). Connect it the pre-amplifier's pre-out terminal.

PROTECTOR

Various protector circuits are included in this unit. The output is interrupted in the following case:

- (1) Muting time, which lasts for several seconds after the power is turned "on".
- (2) When the offset voltage of the power amplifier has drifted outside the prescribed range.
- (3) When the temperature of the power amplifier is abnormally high.
- (4) When a speaker terminal is shorted or a speaker's impedance is extremely low.

This set is equipped with a heat-dissipating motor fan.
The motor fan operates when it senses that the temperature inside the set is high and the heat must be dispersed.

CONNECTIONS

Precautions When Making Connections

- Do not plug the power cord into the power outlet until all the connections have been completed.
- After checking the left and right channels, make proper connections: L with L, and R with R.
- Insert the plugs securely. Incomplete connections will cause noise to be generated.
- Note that bundling pin-plug cords with the power cord or placing pin-plug cords close to the power transformer might lead to the occurrence of hum or noise.

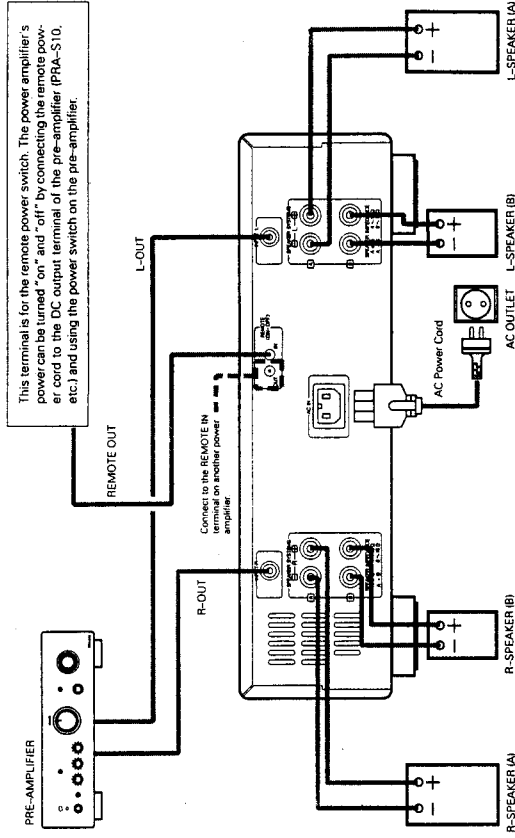

• Connection to the speaker system

- When connecting the speaker terminals to the speaker systems, make certain to connect the polarities correctly (+ to + and - to -). If the polarities are incorrect when the two are connected, the center area of the sound will be lacking, the positions of the musical instruments will not be clear, and the stereo directional sensitivity will be impaired.
- During connection, be careful that the center wires in the speaker cords do not protrude from the terminals to contact any other terminal, and that the central wires in the separate speaker cords do not contact each other.

• Speaker impedance

- When only one of the A or B terminals is used, the speakers that are connected should have a nominal impedance of 4 to 16 Ω/ohms.
- When the two sets (A + B) are to be used at the same time, use of speakers whose impedance is outside the range from 8 to 16 Ω/ohms will result in malfunction. Be careful not to let this happen.
- Speakers with a lower impedance may cause the protective circuitry to operate.

TROUBLESHOOTING

Before troubleshooting, be sure to check whether your audio system is really the source of the problem.

If you think the amplifier is out of order, first check the following one more time:

1. Are all the connections correctly made?
2. Is the set being operated properly in accordance with the Operating Manual?
3. Are the speakers and pre-amplifier being operated correctly?

If the set does not operate properly, perform the checks indicated in the flow chart below.

If none of the items listed apply to the difficulty, the amplifier is probably out of order. Turn off the power immediately, and contact the outlet where you purchased the amplifier or your nearest DENON dealer.

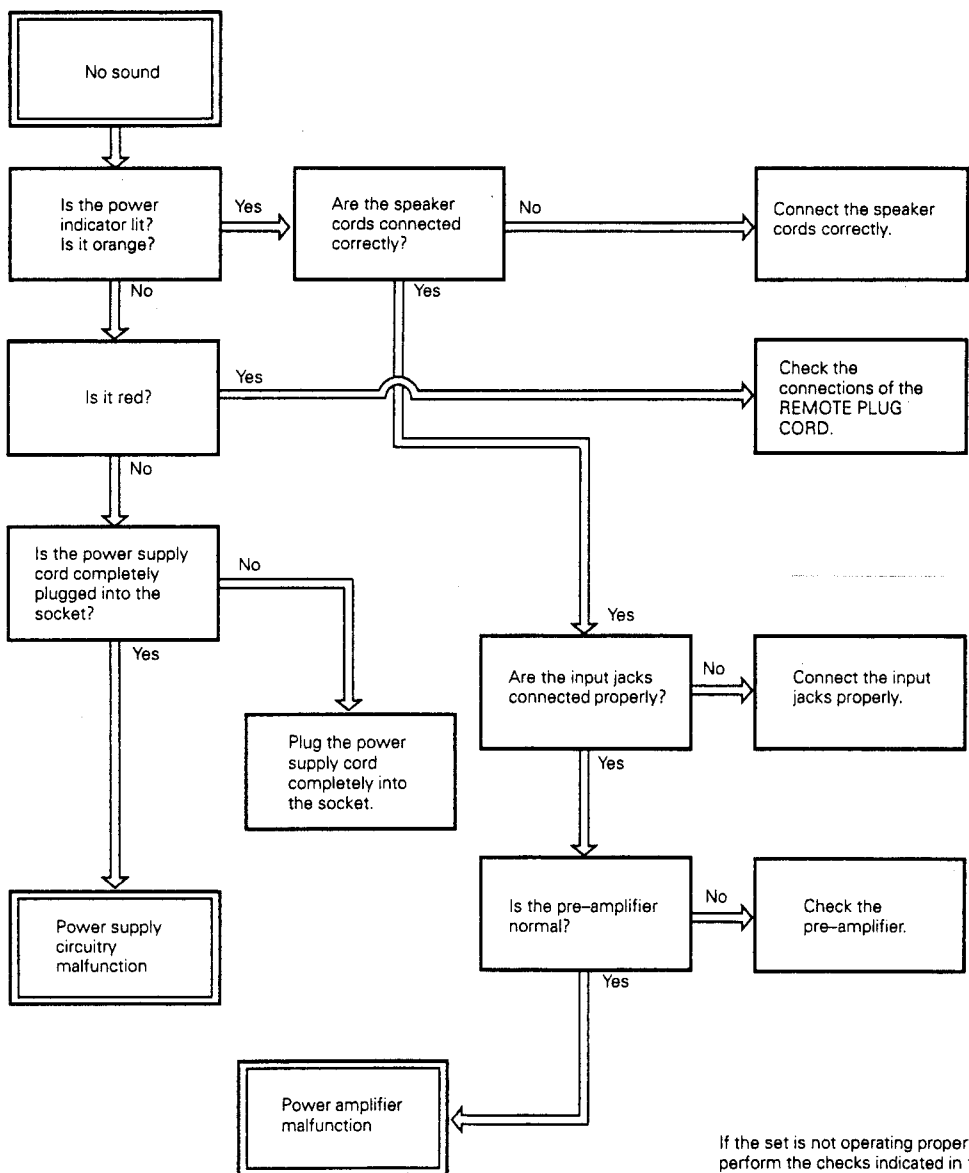

If the set is not operating properly, perform the checks indicated in this flow chart.

| Technical Data (typical value) | Technische Daten (typische werte) | Caractéristiques techniques (valeur caractéristique) | |
|---|---|---|---|
| <p>• POWER AMPLIFIER SECTION</p> <p>Rated Output Power: (8 Ω/ohm Load) 20 Hz to 20 kHz, T.H.D. 0.02% (4Ω/ohm Load) DIN, 1 kHz, T.H.D. 0.5%</p> <p>Total Harmonic Distortion: (-3 dB at rated output, 8 Ω/ohms) (1 kHz)</p> <p>Intermodulation Distortion: (60 Hz/7 kHz: 4/1 at rated output, 8 Ω/ohms)</p> <p>Power Band Width: (8 Ω/ohms, T.H.D. 0.05%)</p> <p>Frequency Response: +0, -3 dB (at 1 W)</p> <p>Input Sensitivity: Normal in:</p> <p>Input Impedance: Normal in:</p> <p>Output Impedance:</p> <p>S / N Ratio: (IHF, A-weighting) (Normal)</p> <p>Output Terminals: Speakers A or B 4 Ω/ohm \sim 16 Ω/ohm A + B 8 Ω/ohm \sim 16 Ω/ohm</p> <p>Power Supply:</p> <p>Power Consumption:</p> <p>Dimensions: (Including control knobs and feet)</p> <p>Weight:</p> | <p>• LEISTUNGSEND VERSTÄRKER</p> <p>Nenn-Ausgangsleistung: (an 8 Ω/Ohm) 20 Hz bis 20 kHz, T.H.D. 0.02% (an 4 Ω/Ohm) DIN, 1 kHz, T.H.D. 0,5%</p> <p>Gesamtklirrfaktor: (-3 dB bei Nennausgang, 8 Ω/Ohm) (1 kHz)</p> <p>Intermodulationsverzerrung: (60 Hz/7 kHz: 4/1 bei Nennausgang, 8 Ω/Ohm)</p> <p>Netzbandbreite: (8 Ω/Ohms, Klirrfaktor 0,05%)</p> <p>Frequenzgang: +0, -3 dB (bei 1 W)</p> <p>Eingangsempfindlichkeit: Normaleingang:</p> <p>Eingangsimpedanz: Normaleingang:</p> <p>Ausgangsimpedanz:</p> <p>Rauschabstand: (IHF, A-bewertet) (Normal)</p> <p>Ausgangsklemmen: Lautsprecher A oder B 4 Ω/Ohm \sim 16 Ω/Ohm A + B 8 Ω/Ohm \sim 16 Ω/Ohm</p> <p>Netzteil:</p> <p>Stromaufnahme:</p> <p>Abmessungen: (einschließlich Reglern und Füßen)</p> <p>Gewicht:</p> | <p>• PARTIE AMPLIFICATEUR DE PUISSANCE</p> <p>Puissance nominale: (charge 8 Ω/ohms) 20 Hz à 20 kHz, D.H.T. 0.02% (charge 4 Ω/ohms) DIN, 1 kHz, T.H.D. 0,5%</p> <p>Distorsion harmonique totale: (-3 dB à la sortie nominale, 8 Ω/ohms) (1 kHz)</p> <p>Distorsion d'intermodulation: (60 Hz/7 kHz: 4/1 sortie nominale, sur 8 Ω/ohms)</p> <p>Bande passante: (8 Ω/ohms, D.H.T. 0,05%)</p> <p>Réponse en fréquence: +0, -3 dB (à 1 W)</p> <p>Sensibilité d'entrée: Normal:</p> <p>Impédance d'entrée: Normal:</p> <p>Impédance de sortie:</p> <p>Rapport S / B: (IHF, pondéré A) (Normal)</p> <p>Bornes de sortie: Enceintes A ou B 4 Ω/ohms \sim 16 Ω/ohms A + B 8 Ω/ohms \sim 16 Ω/ohms</p> <p>Alimentation:</p> <p>Consommation:</p> <p>Dimensions: (avec les commandes et les pieds)</p> <p>Poids:</p> | <p>120 W</p> <p>200 W</p> <p>0.008%</p> <p>0.002%</p> <p>5 Hz \sim 50 kHz</p> <p>1 Hz \sim 100 kHz</p> <p>1.1 V</p> <p>47 kΩ/kohms</p> <p>0.1 Ω/ohm (1 kHz)</p> <p>110 dB</p> <p>AC 230 V / 50 Hz</p> <p>330 W</p> <p>434 (W) \times 135 (H) \times 353 (D) mm (17-3/32" \times 5-11/32" \times 13-19/32")</p> <p>12.3 kg (27 lbs 2 oz)</p> |

- Specifications and contents are subject to change without notice for purposes of improvement.
- Änderungen des Inhalts und der technischen Daten zum Zwecke der Verbesserung vorbehalten.
- Spécifications et contenu sont sujets à modification sans préavis.

DISASSEMBLY (POA-T3)

1. Top Cover

Remove 8 screws (A) fixing the Top Cover and 2 screws (B) mounting the Rear Panel. Detach the Top Cover as shown in arrow direction.

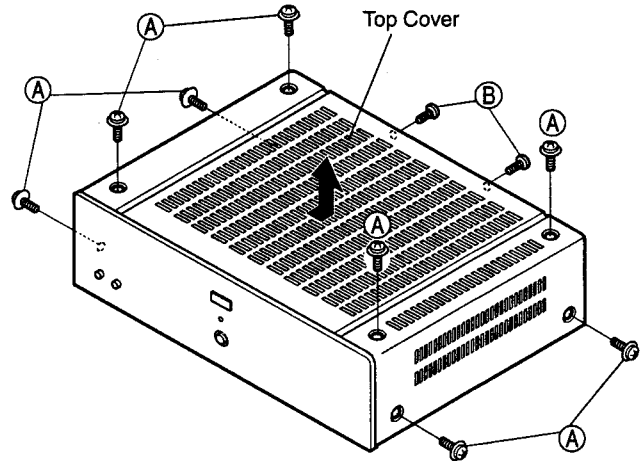

2. Front Panel

Remove 4 upper screws (D) and 2 screws (C) fixing the Front Panel and detach the Front Panel as shown in arrow direction.

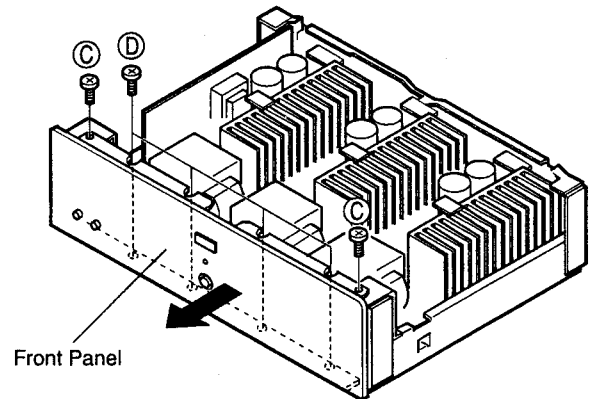

3. Each P.W.Board of Front Panel

- Speaker Switch P.W.Board
Remove 2 screws (E) fixing the Speaker Switch P.W.Board and detach the Speaker Switch P.W.Board as shown in arrow direction.
- Power Supply Switch P.W.Board
Remove 2 screws (F) mounting the Front Panel and detach the Power Supply Switch P.W. Board as shown in arrow direction.
- LED P.W.Board
Undo 2 Hooks and detach the LED P.W.Board.

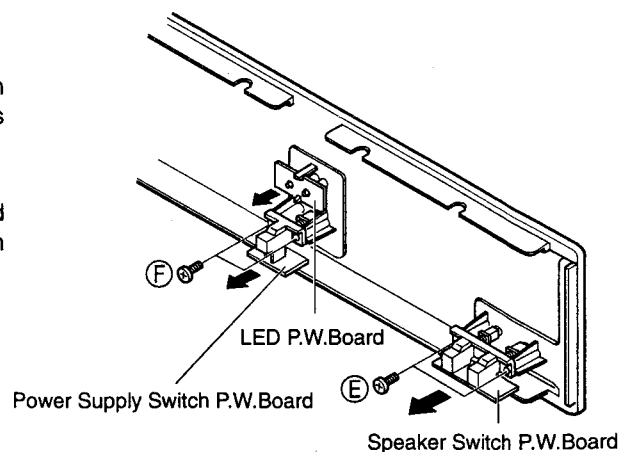

4. Each P.W.Board and Fan of Rear Panel

- Protector P.W.Board
Remove 3 screws (G) fixing the bracket. Detach the Protector P.W.Board as shown in arrow direction.
- Preset P.W.Board
Remove 4 screws (H) fixing the Rear Panel and detach the Preset P.W.Board.
- Input (R, C, L) P.W.Board
Remove each screw (I) fixing the Rear Panel and detach each Input (R, C, L) P.W.Board.
- Fan Cover
Remove 4 screws (J) and detach the Fan Cover.

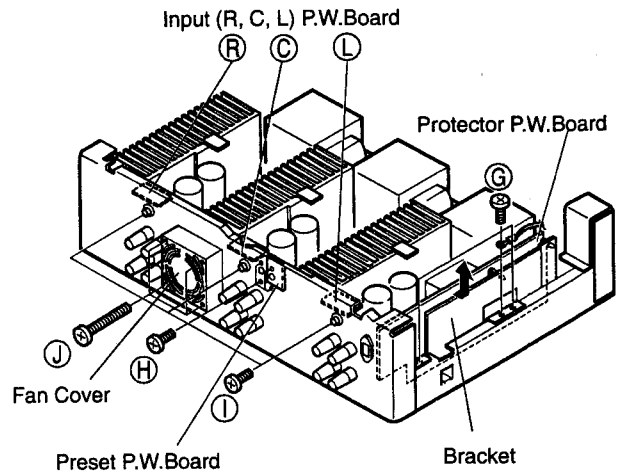

5. Power Supply Transformer

Remove 12 screws (K) mounting the Chassis and detach 3 Power Supply Transformers.

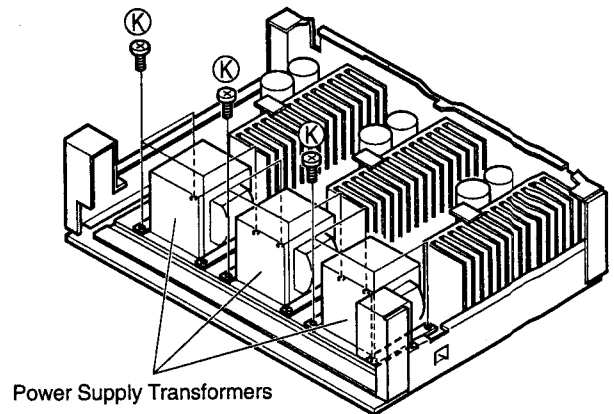

6. Power Amp. P.W.Board

Undo 2 Holders, remove a screw (L) fixing the Rear Panel and 4 screws (M) fixing Radiator Plate of Power Amp. P.W.Board. Detach 3 Power Amp. P.W.Boards as same way above.

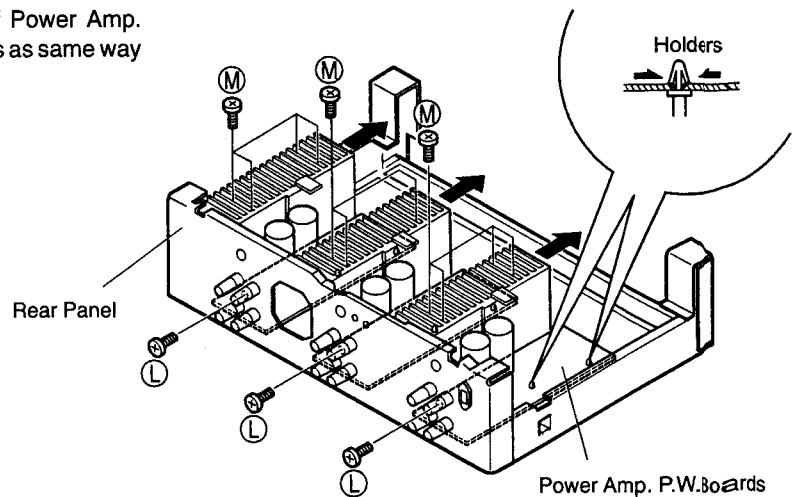

(POA-T2/3200)

1. Top Cover

Remove 8 screws (A) fixing the Top Cover and 2 screws (B) mounting the Rear Panel. Detach the Top Cover as shown in arrow direction.

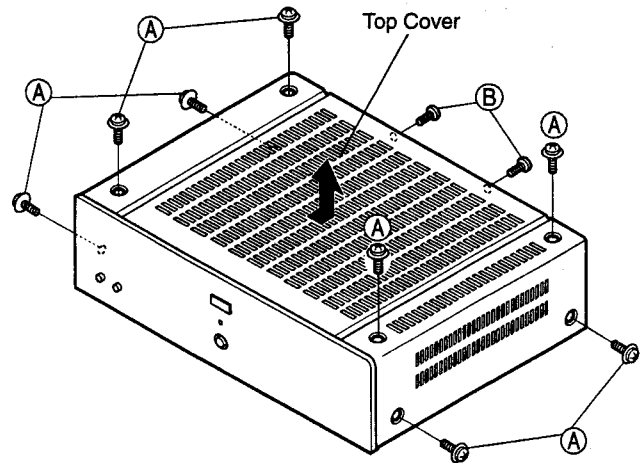

2. Front Panel

Remove 4 upper screws (D) and 2 screws (C) fixing the Front Panel and detach the Front Panel as shown in arrow direction.

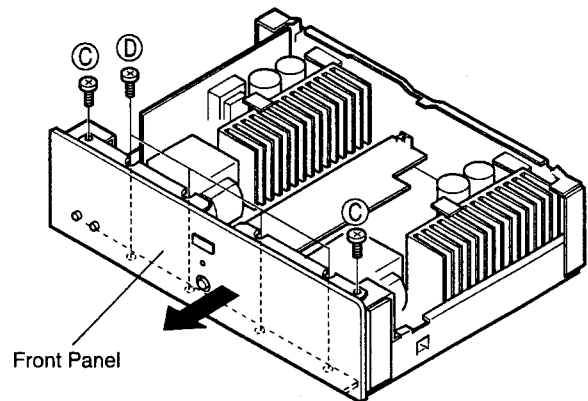

3. Each P.W.Board of Front Panel

- Speaker Switch P.W.Board
Remove 2 screws (E) fixing the Speaker Switch P.W.Board and detach the Speaker Switch P.W.Board as shown in arrow direction.
- Power Supply Switch P.W.Board
Remove 2 screws (F) mounting the Front Panel and detach the Power Supply Switch Board as shown in arrow direction.
- LED P.W.Board
Undo 2 Hooks and detach the LED P.W.Board.

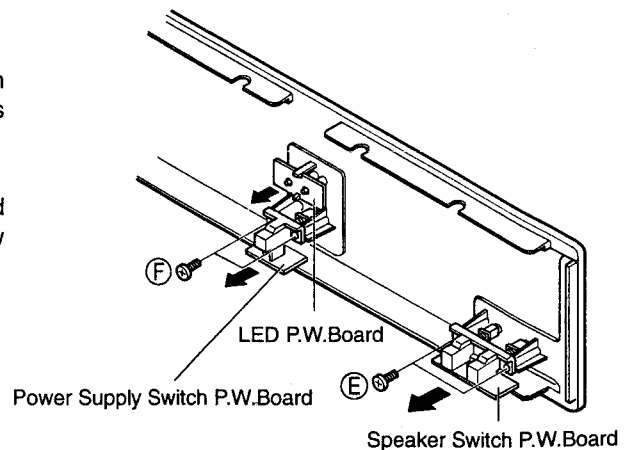

4. Each P.W.Board and Fan of Rear Panel

- Protector P.W.Board
Undo 2 Holders and remove 3 screws (G) fixing Protector P.W.Board. Detach the Protector P.W.Board as shown in arrow direction.
- Preset P.W.Board
Remove 4 screws (H) fixing the Rear Panel and detach the Preset P.W.Board.
- Input (R, L) P.W.Board
Remove each screw (I) fixing the Rear Panel and detach each Input (R, L) P.W.Board.
- Fan Cover (POA-T2 only)
Remove 4 screws (J) and detach the Fan Cover.

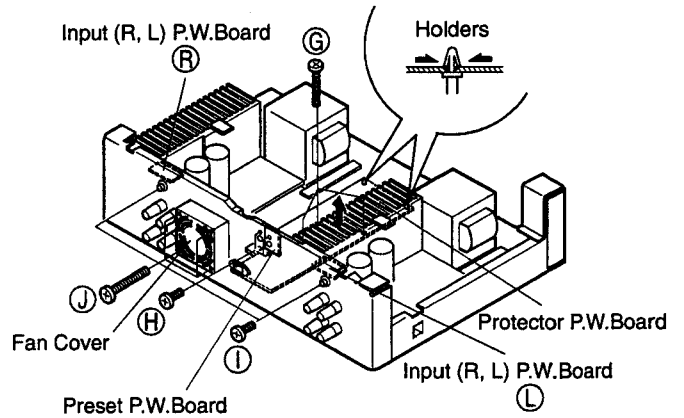

5. Power Supply Transformer

Remove 8 screws (K) mounting the Chassis and detach 2 Power Supply Transformers.

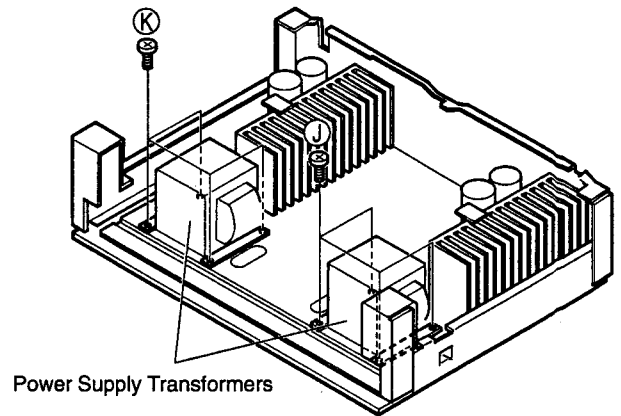

6. Power Amp. P.W.Board

Undo 2 Holders, remove a screw (L) fixing the Rear Panel and 4 screws (M) fixing Radiator Plate of Power Amp. P.W.Board. Detach 2 Power Amp. P.W.Boards as same way above.

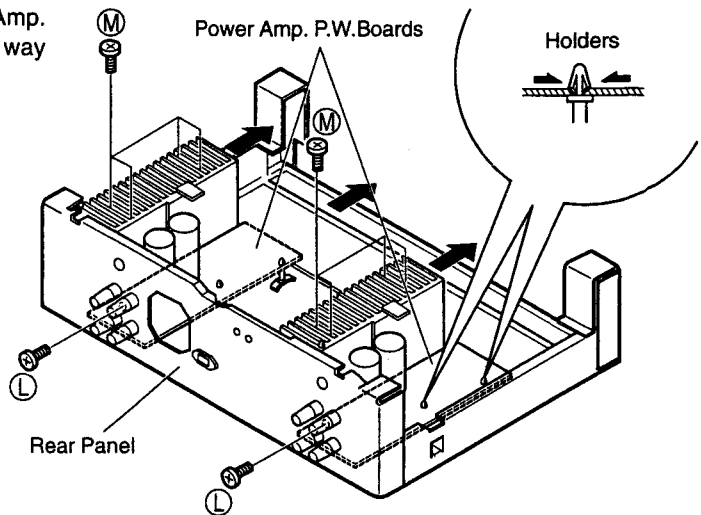

BLOCK DIAGRAM

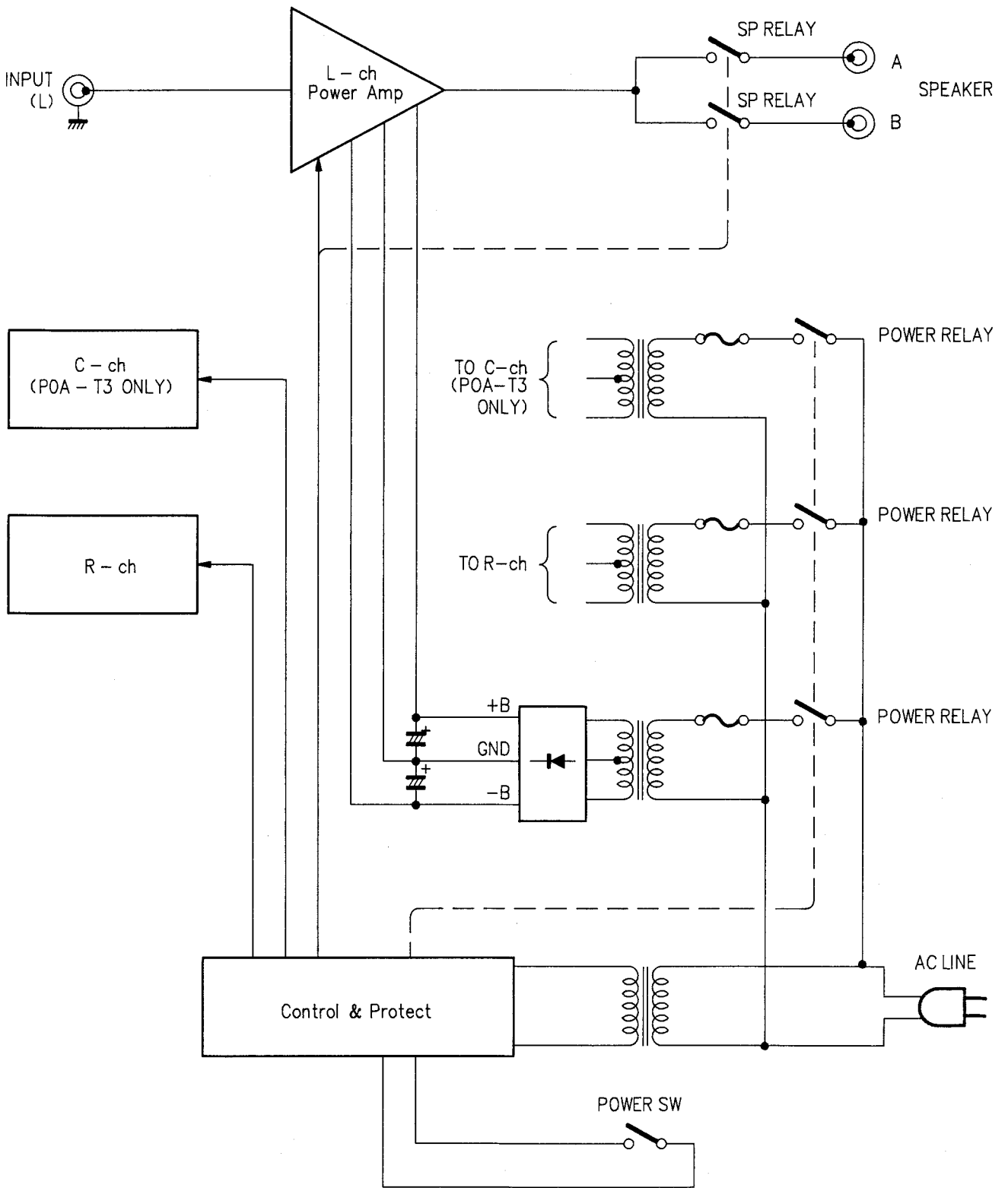

METHOD OF ADJUSTMENT

IDLE CURRENT ADJUSTMENT

● Setup

1. Keep the unit away from direct wind blown by an air-conditioner and an electric fan, and keep the unit under normal conditions. Adjust the range of ambient temperature to 15 – 30°C.
2. Set the following conditions as follows:
 - POWER (Power switch) to off
 - SPEAKERS (Speaker Terminal) to no load (Speakers Disconnected),(But SP-A SW to on.)
 - Disconnect input terminal

● Adjustment

1. Connect DC Voltmeter to Test points (TP101) of 1U-2909.
2. Turn POWER Switch "ON".
3. Adjust VR102 so that the DC Voltmeter reads $2 \pm 0.5\text{mV}$.
4. Then after 3 minutes warm-up time, readjust VR102 so that the DC Voltmeter reads $2 \pm 1\text{mV}$.
5. Adjust each channel as same way above.

OFFSET ADJUSTMENT

● Setup

1. Keep the unit away from direct wind blown by an air-conditioner and an electric fan, and keep the unit under normal conditions. Adjust the range of ambient temperature to 15 – 30°C.
2. Set the following conditions as follows:
 - POWER (Power switch) to off
 - SPEAKERS (Speaker Terminal) to no load (Speakers Disconnected),(But SP-A SW to on.)
 - Disconnect input terminal

● Adjustment

1. Connect Speaker A terminal to DC Voltmeter and oscilloscope.
2. Adjust oscilloscope range to 5mV/div.
3. Turn Power Switch "ON".
4. Adjust VR101 so that the DC Voltmeter reads $0 \pm 1\text{mV}$.
5. Then after 3 minutes warm-up time, readjust VR101 so that the DC Voltmeter reads $0 \pm 1\text{mV}$.
6. Adjust each channel as same way above.

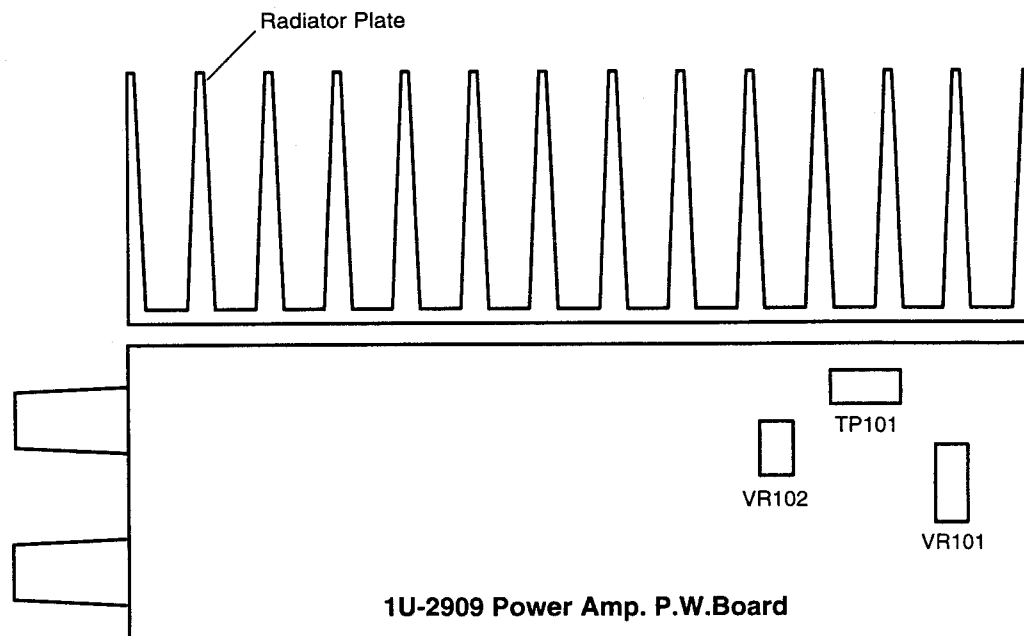

SEMICONDUCTATORS

● TRANSISTORS

2SA1015 (GR)
2SC1815 (BL)
2SC1841 (E/F)

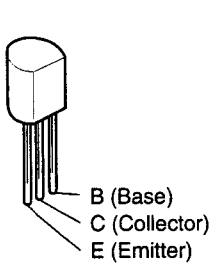

2SA1145 (O)/(Y)
2SC2705 (O)/(Y)

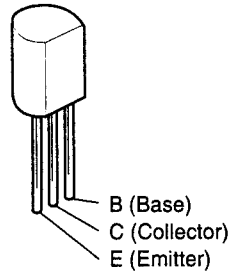

RN1201 (4.7k-4.7k)
RN1202 (10k-10k)

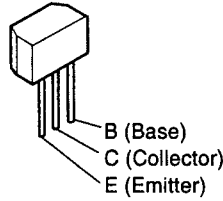

RN1202

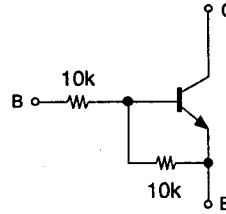

RN1201

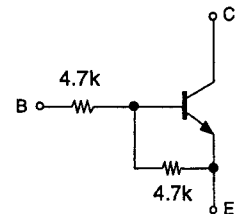

2SA1048 (GR)
2SC2458 (BL)

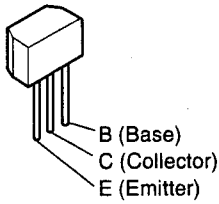

2SC3421

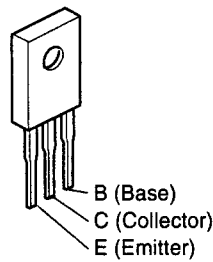

2SA1837-Y
2SC4793-Y

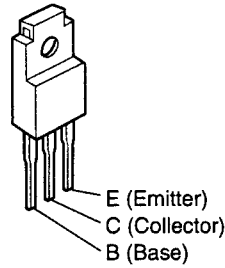

2SA1302 (R/O)
2SC3281 (R/O)

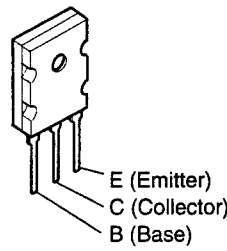

2SK389 (GR)/(BL)/(V)

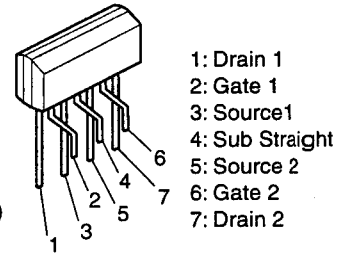

● DIODES (included LED)

HZS2B-1 HZS7B-1
HZS3C-1 HZS7C-1
HZS4B-1

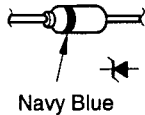

1S2076A
1SS270A

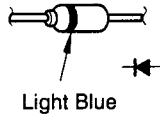

1SR35-200A

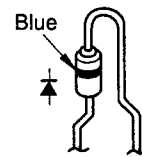

4D4B42

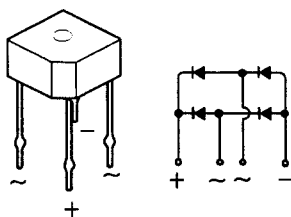

SFOR3G42
(Thyristor)

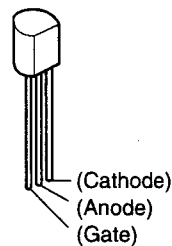

SML1216W (LED)

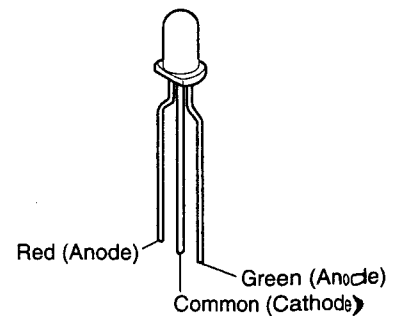

NOTE FOR PARTS LIST

- Part indicated with the mark "◎" are not always in stock and possibly to take a long period of time for supplying, or in some case supplying of part may be refused.
- When ordering of part, clearly indicate "1" and "I" (i) to avoid mis-supplying.
- Ordering part without stating its part number can not be supplied.
- Part indicated with the mark "★" is not illustrated in the exploded view.
- Not including Carbon Film ±5%, 1/4W Type in the P.W.Board parts list. (Refer to the Schematic Diagram for those parts.)

WARNING:

Parts marked with this symbol  have critical characteristics.
Use ONLY replacement parts recommended by the manufacturer.

● Resistors

Ex.: RN 14K 2E 182 G FR
 Type Shape and performance Power Resistance Allowable error Others

| | | | |
|-----------------------|-----------|----------|--------------------------|
| RD : Carbon | 2B : 1/8W | F : ±1% | P : Pulse-resistant type |
| RC : Composition | 2E : 1/4W | G : ±2% | NL : Low noise type |
| RS : Metal oxide film | 2H : 1/2W | J : ±5% | NB : Non-burning type |
| RW : Winding | 3A : 1W | K : ±10% | FR : Fuse-resistor |
| RN : Metal film | 3D : 2W | M : ±20% | F : Lead wire forming |
| RK : Metal mixture | 3F : 3W | | |
| | 3H : 5W | | |

*** Resistance**

1 8 2 ⇒ 1800 ohm = 1.8 kohm
 Indicates number of zeros after effective number.
 2-digit effective number.

• Units: ohm

1 R 2 ⇒ 1.2 ohm
 1-digit effective number.
 2-digit effective number, decimal point indicated by R.

• Units: ohm

● Capacitors

Ex.: CE 04W 1H 2R2 M BP
 Type Shape and performance Dielectric strength Capacity Allowable error Others

| | | | |
|----------------------------------|-----------|-------------|----------------------------------|
| CE : Aluminum foil electrolytic | 0J : 6.3V | F : ±1% | HS : High stability type |
| CA : Aluminum solid electrolytic | 1A : 10V | G : ±2% | BP : Non-polar type |
| CS : Tantalum electrolytic | 1C : 16V | J : ±5% | HR : Ripple-resistant type |
| CQ : Film | 1E : 25V | K : ±10% | DL : For charge and discharge |
| CK : Ceramic | 1V : 35V | M : ±20% | HF : For assuring high frequency |
| CC : Ceramic | 1H : 50V | Z : +80% | U : UL part |
| CP : Oil | 2A : 100V | -20% | C : CSA part |
| CM : Mica | 2B : 125V | P : +100% | W : UL-CSA type |
| CF : Metallized | 2C : 160V | -0% | F : Lead wire forming |
| CH : Metallized | 2D : 200V | C : ±0.25pF | |
| | 2E : 250V | D : ±0.5pF | |
| | 2H : 500V | = : Others | |
| | 2J : 630V | | |

*** Capacity (electrolyte only)**

2 2 2 ⇒ 2200µF
 Indicates number of zeros after effective number.
 2-digit effective number.

• Units: µF.

2 R 2 ⇒ 2.2µF
 1-digit effective number.
 2-digit effective number, decimal point indicated by R.

• Units: µF.

*** Capacity (except electrolyte)**

2 2 2 ⇒ 2200pF = 0.0022µF
 (More than 2) — Indicates number of zeros after effective number.
 2-digit effective number.

• Units: µF.

2 2 1 ⇒ 220pF
 (0 or 1) — Indicates number of zeros after effective number.
 2-digit effective number.

• Units: pF.

• When the dielectric strength is indicated in AC, "AC" is included after the dielectric strength value.

PARTS LIST OF PRINTED WIRING BOARD

1U-2909 MAIN P.W.B. UNIT ASS'Y

| Ref. No. | Part No. | Part Name | Remarks |
|-----------------------------|--------------|---|----------------------------------|
| SEMICONDUCTORS GROUP | | | |
| TR101 | 275 0045 012 | Transistor 2SK389 (GR)/(BL)/(V) | |
| TR103,104 | 273 0235 923 | Transistor 2SC1841 (E/F) | |
| TR105,106 | 271 0168 900 | Transistor 2SA1145 (O)/(Y) | |
| TR108 | 273 0281 906 | Transistor 2SC2705 (O)/(Y) | |
| TR109 | 273 0423 007 | Transistor 2SC4793-Y | |
| TR110 | 271 0272 003 | Transistor 2SA1837-Y | |
| TR115 | 273 0281 906 | Transistor 2SC2705 (O)/(Y) | |
| TR116,117 | 273 0235 923 | Transistor 2SC1841 (E/F) | |
| TR304 | 271 0191 906 | Transistor 2SA1048 (GR) | |
| D101-105 | 276 0432 903 | Diode 1SS270A | |
| D106,106 | 276 0424 005 | Diode 4D4B42 (LC1) | |
| D107,108 | 276 0432 903 | Diode 1SS270A | |
| ZD101,102 | 276 0466 908 | Zener diode HZS7C-1 | |
| ZD103 | 276 0454 907 | Zener diode HZS3C-1 | |
| ZD104 | 276 0456 905 | Zener diode HZS4B-1 | |
| ZD105,106 | 276 0466 908 | Zener diode HZS7C-1 | |
| PT101,101 | 279 0034 067 | Photo transistor PTH9M04BB222TS2F333 | |
| RESISTORS GROUP | | | |
| VR101 | 211 6175 011 | Semi fixed resistor 100ohm | V06PB101(Sermet) |
| VR102 | 211 6075 037 | Semi fixed resistor 10kohm | V06PB103(Sermet) |
| VR103,103 | 211 0741 008 | Variable resistor 50kohm | V1610V25FB503 (POA-3200 only) |
| △ R101 | 241 2426 953 | Carbon 51kohm 1/4W | RD14B2E513J(PSNB) |
| △ R102 | 241 2381 904 | Carbon 3.3kohm 1/4W | RD14B2E332JNBS |
| △ R103 | 241 2375 981 | Carbon 22ohm 1/4W | RD14B2E220JNBS |
| △ R104,105 | 241 2361 946 | Carbon 4.2kohm 1/4W | RD14B2E472JNBS |
| △ R106 | 241 2424 968 | Carbon 8.2kohm 1/4W | RD14B2E822J(PSNB) |
| △ R107 | 241 2379 987 | Carbon 1kohm 1/4W | RD14B2E102JNBS |
| △ R108 | 241 2425 996 | Carbon 30kohm 1/4W | RD14B2E303J(PSNB) |
| △ R109 | 241 2429 963 | Carbon 1Mohm 1/4W | RD14B2E105J(PSNB) |
| △ R110-113 | 244 2051 932 | Metallic 3.3kohm 1W | RS14B3A332JNBS(S) |
| △ R114 | 241 2380 921 | Carbon 1.2kohm 1/4W | RD14B2E152JNBS |
| △ R115,116 | 241 2313 969 | Carbon 47ohm 1/4W | RD14B2E470GFPS |
| △ R117,118 | 241 2316 937 | Carbon 470ohm 1/4W | RD14B2E471GFPS |
| △ R119 | 241 2371 985 | Carbon 91ohm 1/4W | RD14B2E910GFPS |
| △ R120 | 244 2052 999 | Metallic 10kohm 1W | RS14B3A103JNBS(S) |
| △ R121 | 241 2424 942 | Carbon 6.8kohm 1/4W | RD14B2E682J(PSNB) |
| △ R123,124 | 241 2313 901 | Carbon 100ohm 1/4W | RD14B2E101GFPS |
| △ R127 | 241 2387 940 | Carbon 4.7ohm 1/4W | RD14B2E47JNBS |
| △ R128 | 241 2378 920 | Carbon 220ohm 1/4W | RD14B2E221JNBS |
| △ R129 | 241 2387 940 | Carbon 4.7ohm 1/4W | RD14B2E47JNBS |
| △ R130,131 | 243 2061 000 | Wire wound 0.1ohm/3W | RW99-3FDR1K |
| △ R132,133 | 241 2387 940 | Carbon 4.7ohm 1/4W | RD14B2E47JNBS |

| Ref No. | Part No. | Part Name | Remarks |
|---------------------------|--------------|---------------------------|-------------------|
| △ R134,135 | 243 2061 000 | Wire wound 0.1ohm/3W | RW99-3FDR1K |
| △ R136,139 | 244 2051 929 | Metallic 820ohm 1W | RS14B3A821JNBS(S) |
| △ R140 | 244 2051 929 | Metallic 820ohm 1W | RS14B3A821JNBS(S) |
| △ R141,142 | 241 2380 921 | Carbon 1.2kohm 1/4W | RD14B2E152JNBS |
| △ R144 | 244 2043 937 | Metallic 10ohm 1W | RS14B3A100JNBS(S) |
| △ R147 | 244 2050 904 | Metallic 22ohm 1W | RS14B3A220JNBS(S) |
| △ R148 | 244 2051 987 | Metallic 4.7ohm 1W | RS14B3A47JNBS(S) |
| △ R151 | 241 2420 904 | Carbon 100ohm 1/4W | RD14B2E101J(PSNB) |
| △ R152 | 244 2051 929 | Metallic 820ohm 1W | RS14B3A821JNBS(S) |
| △ R154 | 241 2429 963 | Carbon 1Mohm 1/4W | RD14B2E105J(PSNB) |
| CAPACITORS GROUP | | | |
| C000 | 255 6181 073 | Film 27pF/400V | CQ09S2G270KF(B) |
| C101,102 | 254 4356 014 | Electrolytic 100µF/50V | CE04W1H101M(ARS) |
| C103 | 255 4235 950 | Film 6800pF/100V | CQ93P2A682J(NH) |
| C104 | 255 4235 921 | Film 270pF/100V | CQ93P2A271J(NH) |
| C105 | 255 4235 918 | Film 100pF/100V | CQ93P2A101J(NH) |
| C106,106 | 253 4480 903 | Ceramic 27pF/250V | CC45SL2H270J |
| C109 | 255 4235 918 | Film 100pF/100V | CQ93P2A101J(NH) |
| C111 | 255 4232 924 | Film 39pF/100V | CQ93P2A390J(NH) |
| C112 | 255 4235 989 | Film 470pF/100V | CQ93P2A471J(NH) |
| C115,116 | 254 4498 707 | Electrolytic 220µF/25V | CE04W1E221MC(ARS) |
| C117 | 254 4313 963 | Electrolytic 1µF/50V | CE04W1H010M(ASF) |
| C118,118 | 254 4356 027 | Electrolytic 22µF/50V | CE04W1H220M(ARS) |
| C122 | 254 4313 963 | Electrolytic 1µF/50V | CE04W1H010M(ASF) |
| C124 | 255 4235 934 | Film 0.01µF/100V | CQ93P2A103J(NH) |
| C125 | 255 4199 973 | Film 0.01µF/50V | CQ92M1H103J(MRZ) |
| C126,127 | 255 4235 743 | Film 0.022µF/100V | CQ93P2A223J(NH) |
| C130 | 255 4237 903 | Film 2700pF/100V | CQ93P2A272J(NH) |
| C131,132 | 256 1042 903 | Metalzide 0.1µF/250V | CF93A2E104K |
| C133,134 | 255 4237 903 | Film 2700pF/100V | CQ93P2A272J(NH) |
| C138 | 255 4235 918 | Film 100pF/100V | CQ93P2A101J(NH) |
| OTHERS PARTS GROUP | | | |
| | 203 0386 093 | 1P SIN connector Assy | |
| | 203 0602 065 | 1P SIN cord Assy | |
| JK101 | 204 8500 007 | 1P Pin jack (WH) | |
| | 205 0185 038 | 3P wire holder | |
| TP101 | 205 0190 036 | 3P NH connector base | |
| CB101 | 205 0278 039 | 3P EH connector base (BK) | |
| CB102 | 205 0233 032 | 3P EH connector base | |
| CN101 | 205 0278 039 | 3P EH connector base (BK) | |
| CN102 | 205 0233 032 | 3P EH connector base | |
| CN103 | 205 0355 062 | 6P KR connector base (L) | |
| SP101 | 205 0991 002 | 4P Terminal (S-GND) | |
| RL101,102 | 214 0167 005 | Relay(G5Z-2A) | |
| L101 | 235 0068 004 | Inductor(1MH) | |
| | 415 0309 013 | PVC tube (L=10) | |

1U-2910 CONTROL P.W.B. UNIT ASS'Y

| Ref. No. | Part No. | Part Name | Remarks | |
|--|--------------|------------------------------|----------------------------------|----------------|
| SEMICONDUCTORS GROUP | | | | |
| TR301 | 273 0317 906 | Transistor 2SC2458(BL) | (POA-T3G only) | |
| TR302,303 | 269 0023 903 | Transistor RN1201(4.4k-4.7k) | | |
| TR304 | 271 0191 906 | Transistor 2SA1048(GR) | | |
| TR305,306 | 273 0317 906 | Transistor 2SC2458(BL) | | |
| TR307 | 273 0317 906 | Transistor 2SC2458(BL) | | |
| TR308 | 273 0198 015 | Transistor 2SC1815(BL) | | |
| TR309 | 273 0317 906 | Transistor 2SC2458(BL) | | |
| TR310 | 271 0102 924 | Transistor 2SA1015(GR) | | |
| TR311 | 271 0191 906 | Transistor 2SA1048(GR) | | |
| TR312,313 | 273 0317 906 | Transistor 2SC2458(BL) | | |
| TR314 | 271 0191 906 | Transistor 2SA1048(GR) | | |
| TR315-317 | 273 0317 906 | Transistor 2SC2458(BL) | | |
| TR318 | 273 0235 923 | Transistor 2SC1841(E/F) | | |
| TR319 | 271 0191 906 | Transistor 2SA1048(GR) | | |
| TR320 | 273 0235 923 | Transistor 2SC1841(E/F) | | |
| TR321 | 271 0191 906 | Transistor 2SA1048(GR) | | (POA-T3G only) |
| TR322 | 273 0235 923 | Transistor 2SC1841(E/F) | | (POA-T3G only) |
| TR324 | 269 0025 901 | Transistor RN1202(10k-10k) | | (POA-T3G only) |
| TR325 | 269 0025 901 | Transistor RN1202(10k-10k) | | |
| TR326 | 269 0023 903 | Transistor RN1201(4.4k-4.7k) | | |
| TR327 | 273 0317 906 | Transistor 2SC2458(BL) | | |
| D001 | 276 0432 903 | Diode 1SS270A | | (POA-T3G only) |
| D002,003 | 276 0432 903 | Diode 1SS270A | | |
| D301-303 | 276 0432 903 | Diode 1SS270A | | |
| D304-309 | 276 0553 905 | Diode 1SR35-200A | | |
| D310-313 | 276 0432 903 | Diode 1SS270A | | |
| ZD301 | 276 0450 901 | Zener diode HZS2B-1 | | (POA-T3G only) |
| ZD302,303 | 276 0456 905 | Zener diode HZS4B-1 | | |
| ZD304 | 276 0456 905 | Zener diode HZS4B-1 | | |
| ZD305 | 276 0465 909 | Zener diode HZS7B-1 | | |
| SC301 | 279 0038 908 | SCR SFOR3G42 | | |
| RESISTORS GROUP (Not included carbon film ±5% 1/4W) | | | | |
| CAPACITORS GROUP | | | | |
| △ C001 | 253 9014 702 | Ceramic 0.01μF/400V AC | CK45F2GAC103MC (POA-T3G only) | |
| △ C002,003 | 253 9014 702 | Ceramic 0.01μF/400V AC | CK45F2GAC103MC | |
| C005 | 255 4223 920 | Film 0.01μF/50V | CQ92M1H103J(MRZ) | |
| C301,302 | 253 1146 907 | Ceramic 0.01μF/50V | CK45F1H103Z | |
| C303,304 | 254 4254 909 | Electrolytic 10μF/16V | CE04W1C100M | |
| C305 | 254 4254 909 | Electrolytic 10μF/16V | CE04W1C100M (POA-T3G only) | |
| C307 | 254 4252 943 | Electrolytic 220μF/10V | CE04W1A221M | |
| C308 | 254 4254 909 | Electrolytic 10μF/16V | CE04W1C100M | |

| Ref No. | Part No. | Part Name | Remarks |
|---------------------------|------------------------------|-----------------------------------|---------------------------------|
| C310 | 254 4250 932 | Electrolytic 220μF/6.3V | CE04W0J221M |
| C311 | 254 4260 948 | Electrolytic 1μF/50V | CE04W1H010M |
| C312 | 254 4260 919 | Electrolytic 0.22μF/50V | CE04W1HR22M |
| C313 | 254 4254 792 | Electrolytic 2200μF/16V | CE04W1C222MC |
| C314 | 254 4256 949 | Electrolytic 100μF/25V | CE04W1E101M |
| C315 | 254 4256 949 | Electrolytic 100μF/25V | CE04W1E101M (POA-T3G only) |
| OTHERS PARTS GROUP | | | |
| △ | 202 0040 909 | Fuse dip | |
| | 203 0644 007 | 1P SIN cord Assy | |
| JK301,302 | 204 8101 008 | 2P Power jack | |
| △ CN001 | 205 0606 025 | 2P Wrapping terminal | (POA-3200/POA-T2G) (POA-T3G) |
| △ CN002,003 | 205 0606 025 | 2P Wrapping terminal | |
| △ CN002,003 | 205 0606 036 | 3P Wrapping terminal | |
| CN301,301 | 205 0233 032 | 3P EH connector base | |
| CN302,302 | 205 0277 030 | 3P EH connector base (RD) | |
| CN303,303 | 205 0296 037 | 3P EH connector base (YW) | |
| CN304-306 | 205 0233 061 | 6P EH connector base | |
| CN307,307 | 205 0276 031 | 3P EH connector base (BU) | |
| CN308,308 | 205 0949 038 | 3P EH connector base (GR) | |
| △ F001 | 206 1015 061 | Fuse 2A | (POA-T3G only) |
| △ F002,003 | 206 1015 061 | Fuse 2A | |
| SW301 | 212 4791 002 | 2P push switch | |
| SW303 | 212 1056 009 | 1P push switch | |
| △ RL001 | 214 0142 004 | Relay(TV-5) | (POA-T3G only) |
| △ RL002,003 | 214 0142 004 | Relay(TV-5) | |
| △ T301 | 233 5746 006 | Power trans (EU mini) | |
| P301 | 279 0034 041 | Thermistor PTH9M04BD222TS2F333 | |
| LD001 | 393 9491 004 513 9406 004 | LED (SML1216W) Fuse label | T2.0A |

PARTS LIST OF EXPLODED VIEW (POA-T3)

| Ref. No. | Part No. | Part Name | Remarks | Q'ty | Ref. No. | Part No. | Part Name | Remarks | Q'ty |
|----------|--------------|---------------------------|--------------|------|----------------------------------|--------------|-----------------------------|---------|------|
| 1 | 1U- 2909 | Main P.W.B. unit Ass'y | | 3 | 45 | 412 9499 006 | Support braket (R) | | 1 |
| 1-1 | — | Power amp. P.W.B. unit | | | 46 | 412 9497 008 | Support braket (L) | | 1 |
| 1-2 | — | Input P.W.B. unit | | | 47 | — | | | |
| 2 | 1U- 2910 B | Control P.W.B. unit Ass'y | | 1 | 48 | — | | | |
| 2-1 | — | Control P.W.B. unit | | | 49 | — | | | |
| 2-2 | — | SP. switch P.W.B. unit | | | 50 | — | | | |
| 2-3 | — | Remote P.W.B. unit | | | 51 | 412 2814 028 | Card spacer (L=10) | | 2 |
| 2-4 | — | Power switch P.W.B. unit | | | 52 | — | | | |
| 2-5 | — | LED P.W.B. unit | | | 53 | — | | | |
| 3 | 105 1188 200 | Bottom cover | | 1 | 54 | 477 0096 007 | Push rivet | | 12 |
| 4 | 412 4078 105 | Angle (A) | | 1 | ★ | 001 0085 073 | Vinyl wire | | 1 |
| 5 | 412 4089 107 | Angle (B) | | 1 | ★ | 001 0085 086 | Vinyl wire | | 1 |
| 6 | 412 4079 201 | Trans bracket | | 1 | ★ | 203 5111 027 | 3P EH-EH shield | CN101×3 | 3 |
| 7 | 411 9136 117 | Side chassis | | 2 | ★ | 203 5134 004 | 3P EH-EH connector cord | | 2 |
| 8 | 104 9044 000 | Foot Ass'y | | 4 | ★ | 203 5134 017 | 3P EH-EH connector cord | CN301 | 1 |
| 9 | 105 1189 319 | Rear panel | | 1 | ★ | 203 5134 020 | 3P EH-EH connector cord | CN302 | 1 |
| 10 | 415 9016 035 | P.W.B. holder | | 6 | ★ | 203 5135 003 | 3P PH-PH connector cord | CN307 | 1 |
| 11 | 417 0530 105 | Radiator | | 3 | ★ | 203 5135 016 | 3P PH-PH connector cord | CN308 | 1 |
| 12 | 412 4080 106 | Radiator plate | | 6 | ★ | 204 0378 091 | 6P KR-KR ribbon 250 | CN103A | 1 |
| 13 | 412 3225 205 | P.W.B.bracket (A) | | 6 | ★ | 204 0379 058 | 6P KR-KR ribbon 400 | CN103B | 1 |
| 14 | 273 0391 003 | 2SC3281 (R/O) | TR111,113×3 | 6 | ★ | 415 0777 001 | UL tube | | 1 |
| 15 | 271 0245 001 | 2SA1302 (R/O) | TR112,114×3 | 6 | ★ | 415 0393 029 | UL tube (12.7) | | 1 |
| 16 | 273 0323 000 | 2SC3421 (O/Y) | TR107×3 | 3 | ★ | 445 0048 016 | Cord holder (L50) | | 6 |
| 17 | 254 4500 006 | Electrolytic 6800μF/71V | C128,129×3 | 6 | SCREWS | | | | |
| 18 | 412 9503 002 | P.W.B.bracket (IN) | | 1 | 101 | 473 7002 034 | Screw 3×6 CBTS(S)-B | | 45 |
| 19 | 412 3548 021 | P.W.B.catcher | | 4 | 102 | 473 7508 046 | Screw 3×16 CBTS(P)-B | | 3 |
| 20 | 415 9016 019 | P.W.B.holder | | 2 | 103 | 477 0064 107 | Fixing screw | | 10 |
| 21 | 144 2491 111 | Fan cover | | 1 | 104 | 473 8050 014 | Screw 3×30 CBTS(2)-B | | 4 |
| 22 | 421 0722 006 | Motor fan | | 1 | 105 | 473 7007 000 | Screw 4×8 CBTS(S)-B | | 25 |
| 23 | 412 4081 105 | Front bracket (L) | | 1 | 106 | 473 7500 044 | Screw 3×8 CBTS(P)-B | | 7 |
| 24 | 412 4082 104 | Front bracket (R) | | 1 | 107 | 473 7015 005 | Screw 3×6 CBTS(S)-B | | 6 |
| △ 25 | 233 6200 006 | Power trans (E2) | | 3 | 108 | 471 9043 008 | Special screw 4×10 CBTS-S-G | | 8 |
| △ 26 | 203 3970 006 | AC inlet | | 1 | 109 | 473 7015 018 | Screw 3×8 CBTS(S)-B | | 2 |
| 27 | 415 9059 005 | Insulating sheet | | 12 | 110 | 473 8034 001 | Screw 3×8 CBTS(B)-CU | | 15 |
| 28 | 144 2489 259 | Front panel Ass'y | | 1 | 111 | 473 8007 038 | Cup screw 3×14 | | 15 |
| 29 | — | | | | 112 | 473 7003 017 | Screw 3×8 CFTS(S)-B | | 2 |
| 30 | 461 9001 001 | Rubber sheet | | 2 | PACKING & ACCESSORIES | | | | |
| 31 | 461 0390 012 | Rubber sheet | | 4 | | 203 4442 001 | Remote plug cord | | 1 |
| 32 | 122 9006 004 | Spacer | | 1 | | 206 2147 006 | AC cord with connector | | 1 |
| 33 | 113 9303 101 | Power button Ass'y | | 1 | | 501 9265 064 | Carton case | | 1 |
| 34 | 143 0952 002 | Lens | | 1 | | 503 9275 102 | Cushion | | 2 |
| 35 | 146 1606 013 | LED guide | | 1 | | 504 9102 003 | Stylene paper | | 1 |
| 36 | 113 1356 062 | Push button (MARU) | | 2 | | 505 8006 019 | Envelope | | 1 |
| 37 | 102 9048 246 | Top cover | | 1 | | 505 9102 006 | Poly cover | | 1 |
| 38 | 205 0991 002 | 4P terminal (S-GND) | SP101×3 | 3 | | 511 9445 001 | Instructions manual | | 1 |
| 39 | 204 8500 007 | 1P pin jack (WH) | JK101×3 | 3 | | 513 9111 001 | Color label (GOLD) | | 2 |
| 40 | 204 8101 008 | 2P power jack | JK301,302 | 2 | | | | | |
| 41 | 212 4791 002 | 2P push switch | SW301 | 1 | | | | | |
| 42 | 212 1056 009 | 1P push switch | SW303 | 1 | | | | | |
| △ 43 | 233 0199 007 | Power trans (E2 mini) | T301 | 1 | | | | | |
| △ 44 | 206 1015 061 | Fuse 2A | F001,002,003 | 3 | | | | | |

EXPLODED VIEW (POA-T3)

1 2 3 4 5 6 7 8

WARNING:
Parts marked with this symbol  have critical characteristics.
Use ONLY replacement parts recommended by the manufacturer.

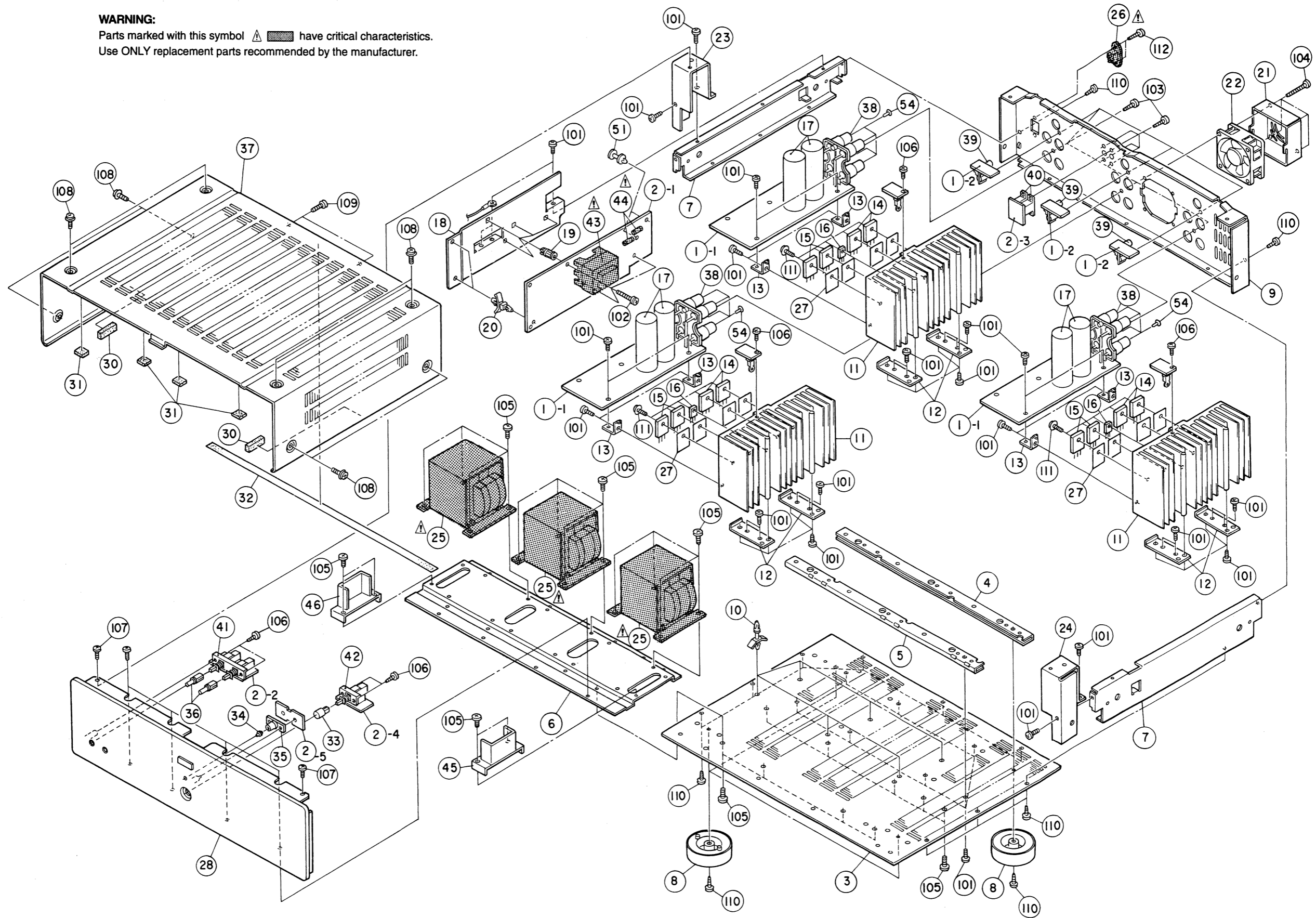

A
B
C
D
E

PARTS LIST OF EXPLODED VIEW (POA-T2/3200)

| Ref. No. | Part No. | Part Name | Remarks | Q'ty | Ref. No. | Part No. | Part Name | Remarks | Q'ty |
|----------------------------------|--------------|---------------------------|-----------------------------|------|----------|--------------|-------------------------|----------------|------|
| 1 | 1U-2909 | Main P.W.B. unit Ass'y | (POA-3200) | 2 | 44 | 206 1015 061 | Fuse 2A | F002,003 | 2 |
| 1 | 1U-2909 | Main P.W.B. unit Ass'y | (POA-T2G) | 2 | 45 | 412 9499 006 | Support brakel (R) | | 1 |
| 1-1 | - | Power amp. P.W.B. unit | | | 46 | 412 9497 008 | Support brakel (L) | | 1 |
| 1-2 | - | Input P.W.B. unit | | | 47 | - | | | |
| 2 | 1U-2910 E | Control P.W.B. unit Ass'y | (POA-3200) | 1 | 48 | 461 0390 041 | Rubber sheet | | 2 |
| 2 | 1U-2910 A | Control P.W.B. unit Ass'y | (POA-T2G) | 1 | 49 | 449 0050 048 | Card spacer | | 2 |
| 2-1 | - | Control P.W.B. unit | | | 50 | 449 0050 022 | Card spacer | | 2 |
| 2-2 | - | SP. switch P.W.B. unit | | | 51 | 412 2814 028 | Card spacer (L=10) | | 2 |
| 2-3 | - | Remote P.W.B. unit | | | 52 | - | | | |
| 2-4 | - | Power switch P.W.B. unit | | | 53 | - | | | |
| 2-5 | - | LED P.W.B. unit | | | 54 | 477 0096 007 | Push rivet | | 8 |
| 3 | 105 1188 200 | Bottom cover | | 1 | ★ | 001 0085 073 | Vinyl wire | | 1 |
| 4 | 412 4078 105 | Angle (A) | | 1 | ★ | 001 0085 086 | Vinyl wire | | 1 |
| 5 | 412 4089 107 | Angle (B) | | 1 | ★ | 203 5111 027 | 3P EH-EH shield | CN101×2 | 2 |
| 6 | 412 4079 201 | Trans bracket | | 1 | ★ | 203 5134 004 | 3P EH-EH connector cord | | 2 |
| 7 | 411 9136 117 | Side chassis | | 2 | ★ | 203 5134 017 | 3P EH-EH connector cord | CN301 | 1 |
| 8 | 104 9044 000 | Foot Ass'y | | 4 | ★ | 203 5134 020 | 3P EH-EH connector cord | CN302 | 1 |
| 9 | 105 1189 364 | Rear panel | (POA-3200) | 1 | ★ | 203 5135 003 | 3P PH-PH connector cord | CN307 | 1 |
| 9 | 105 1189 335 | Rear panel | (POA-T2G) | 1 | ★ | 203 5135 016 | 3P PH-PH connector cord | CN308 | 1 |
| 10 | 415 9016 035 | P.W.B. holder | | 4 | ★ | 204 0378 091 | 6P KR-KR ribbon 250 | CN103A | 1 |
| 11 | 417 0530 105 | Radiator | | 4 | ★ | 204 0379 058 | 6P KR-KR ribbon 400 | CN103B | 1 |
| 12 | 412 4080 106 | Radiator plate | | 4 | ★ | 415 0777 001 | UL tube | | 1 |
| 13 | 412 3225 205 | P.W.B.bracket (A) | | 4 | ★ | 415 0393 029 | UL tube (12.7) | (POA-T2G only) | 1 |
| 14 | 273 0391 003 | 2SC3281 (R/O) | TR111,113×2 | 4 | ★ | 445 0048 016 | Cord holder (L50) | | 6 |
| 15 | 271 0245 001 | 2SA1302 (R/O) | TR112,114×2 | 4 | | | | | |
| 16 | 273 0323 000 | 2SC3421 (O/Y) | TR107×2 | 2 | | | | | |
| 17 | 254 4500 006 | Electrolytic 6800μF/71V | C128,129×2 | 2 | | | | | |
| 18 | 412 9503 002 | P.W.B.bracket (IN) | | 1 | | | | | |
| 19 | 412 3548 021 | P.W.B.catcher | | 5 | | | | | |
| 20 | 415 9016 019 | P.W.B.holder | | 2 | | | | | |
| 21 | 144 2491 111 | Fan cover | (POA-T2G only) | 1 | | | | | |
| 22 | 421 0722 006 | Motor fan | (POA-T2G only) | 1 | | | | | |
| 23 | 412 4081 105 | Front bracket (L) | | 1 | | | | | |
| 24 | 412 4082 104 | Front bracket (R) | | 1 | | | | | |
| 25 | 233 6200 006 | Power trans (E2) | | 2 | | | | | |
| 26 | 203 3970 006 | AC inlet | | 1 | | | | | |
| 27 | 415 9059 005 | Insulating sheet | | 8 | | | | | |
| 28 | 144 2489 246 | Front panel Ass'y | (POA-3200) | 1 | | | | | |
| 28 | 144 2489 262 | Front panel Ass'y | (POA-T2G) | 1 | | | | | |
| 29 | - | | | | | | | | |
| 30 | 461 9001 001 | Rubber sheet | | 2 | | | | | |
| 31 | 461 0390 012 | Rubber sheet | | 4 | | | | | |
| 32 | 122 9006 004 | Spacer | | 1 | | | | | |
| 33 | 113 9303 101 | Power button Ass'y | | 1 | | | | | |
| 34 | 143 0952 002 | Lens | | 1 | | | | | |
| 35 | 146 1606 013 | LED guide | | 1 | | | | | |
| 36 | 113 1356 062 | Push button (MARU) | | 2 | | | | | |
| 37 | 102 9048 246 | Top cover | | 1 | | | | | |
| 38 | 205 0991 002 | 4P terminal (S-GND) | SP101×2 | 2 | | | | | |
| 39 | 204 8500 007 | 1P pin jack (WH) | JK101×2 | 2 | | | | | |
| 40 | 204 8101 008 | 2P power jack | JK301,302 | 2 | | | | | |
| 41 | 212 4791 002 | 2P push switch | SW301 | 1 | | | | | |
| 42 | 212 1056 009 | 1P push switch | SW303 | 1 | | | | | |
| 43 | 233 6199 007 | Power trans (E2 mini) | T301 | 1 | | | | | |
| SCREWS | | | | | | | | | |
| | 101 | 473 7002 034 | Screw 3×6 CBTS (S)-B | 36 | | | | | |
| | 102 | 473 7508 046 | Screw 3×16 CBTS (P)-B | 3 | | | | | |
| | 103 | 477 0064 107 | Fixing screw | 8 | | | | | |
| | 104 | 473 8050 014 | Screw 3×30 CBTS (2)-B | 4 | | | | (POA-T2G only) | |
| | 105 | 473 7007 000 | Screw 4×8 CBTS (S)-B | 21 | | | | | |
| | 106 | 473 7500 044 | Screw 3×8 CBTS (P)-B | 6 | | | | | |
| | 107 | 473 7015 005 | Screw 3×6 CBTS (S)-B | 6 | | | | | |
| | 108 | 471 9043 008 | Special screw 4×10 CBTS-S-G | 8 | | | | | |
| | 109 | 473 7015 018 | Screw 3×8 CBTS (S)-B | 2 | | | | | |
| | 110 | 473 8034 001 | Screw 3×8 CBTS (B)-CU | 15 | | | | | |
| | 111 | 473 8007 038 | Cup screw 3×14 | 10 | | | | | |
| | 112 | 473 7003 017 | Screw 3×8 CFTS (S)-B | 2 | | | | | |
| PACKING & ACCESSORIES | | | | | | | | | |
| | | 203 4442 001 | Remote plug cord | 1 | | | | | |
| | | 206 2147 006 | AC cord with connector | 1 | | | | | |
| | | 501 9265 077 | Carton case | 1 | | | | (POA-T2G) | |
| | | 501 9285 002 | Carton case | 1 | | | | (POA-3200) | |
| | | 503 9275 102 | Cushion | 2 | | | | | |
| | | 504 9102 003 | Stylene paper | 1 | | | | | |
| | | 505 8006 019 | Envelope | 1 | | | | | |
| | | 505 9102 006 | Poly cover | 1 | | | | | |
| | | 511 9446 000 | Instructions manual | 1 | | | | (POA-T2G) | |
| | | 511 9449 007 | Instructions manual | 1 | | | | (POA-3200) | |
| | | 513 9111 001 | Color label (GOLD) | 2 | | | | | |

EXPLODED VIEW (POA-T2/3200)

1 2 3 4 5 6 7 8

WARNING:
Parts marked with this symbol  have critical characteristics.
Use ONLY replacement parts recommended by the manufacturer.

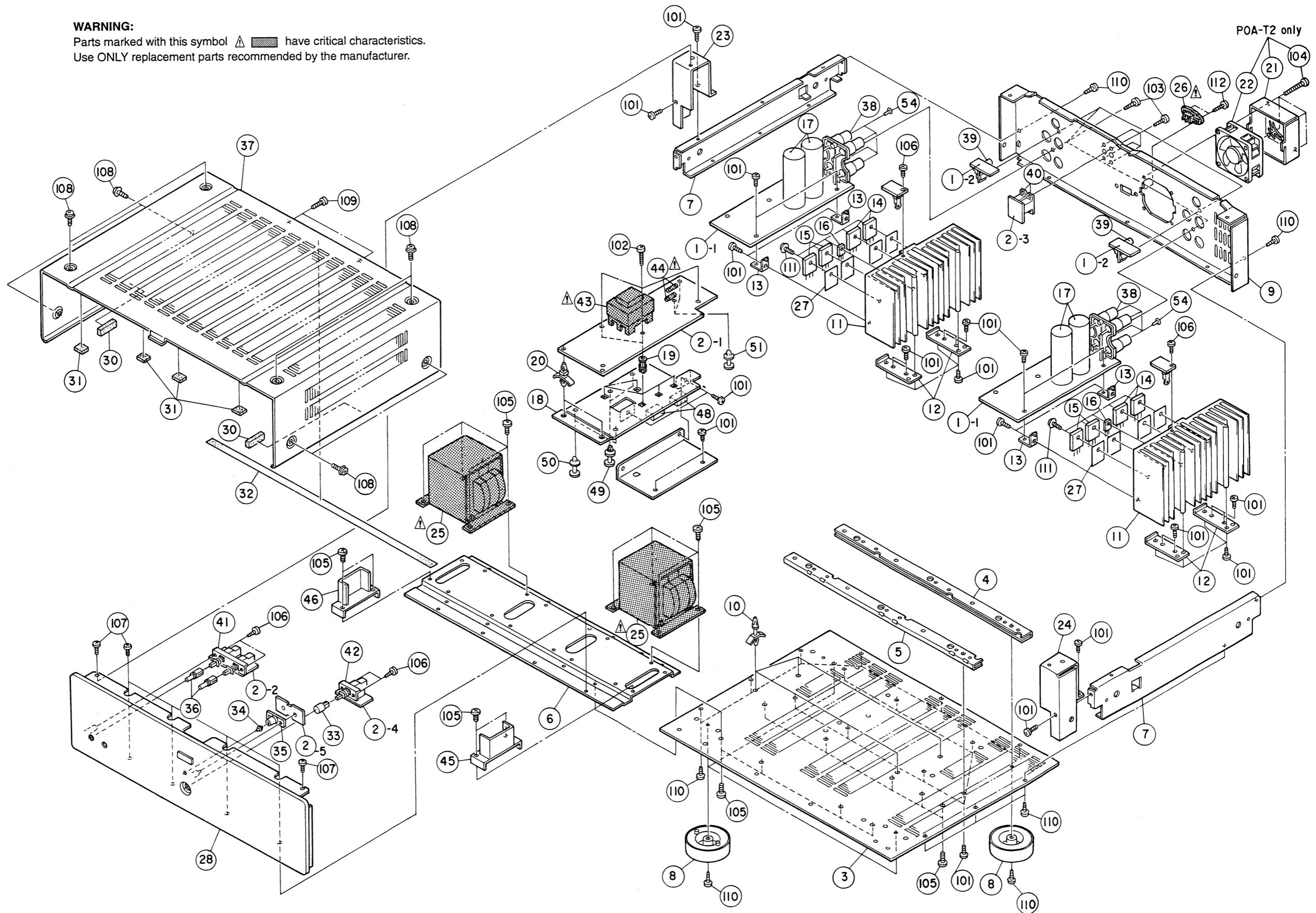

A

B

C

D

E

PRINTED WIRING BOARD

1 2 3 4 5 6 7 8

1U-2909 MAIN P.W.B. UNIT ASS'Y

A

B

C

D

E

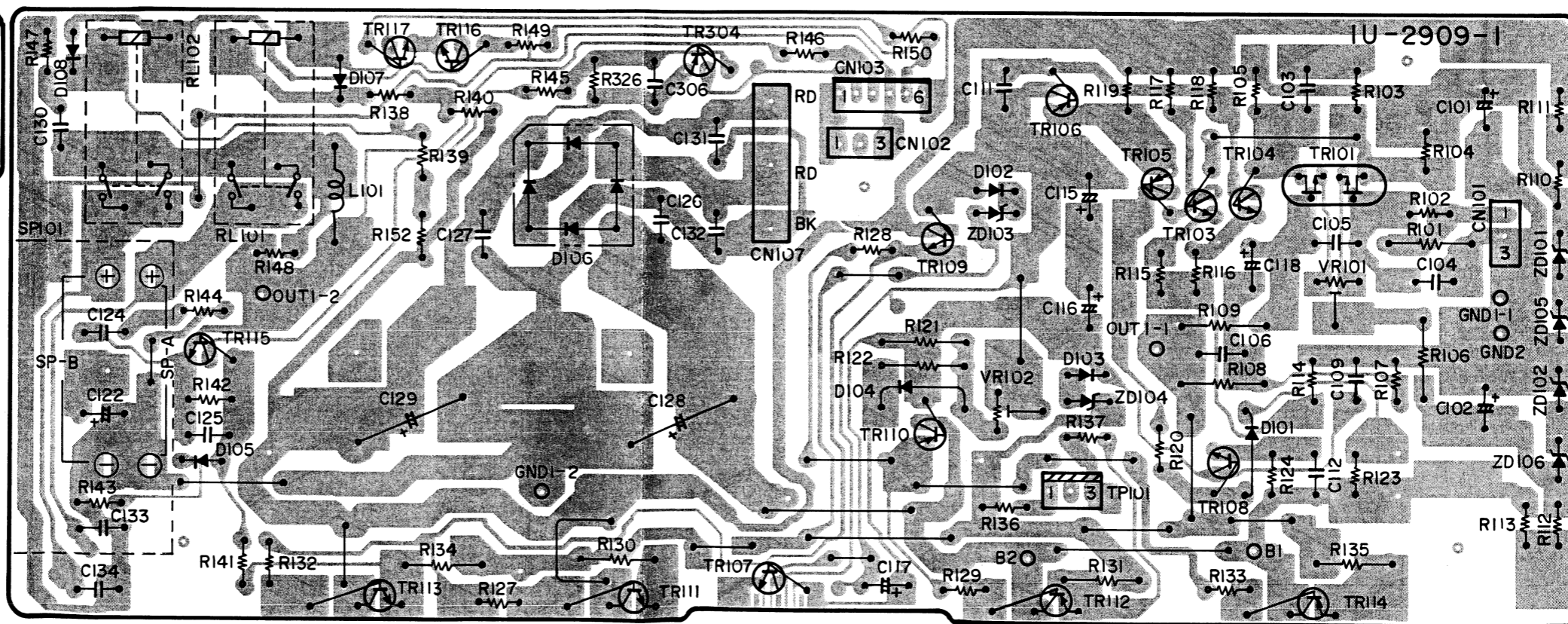
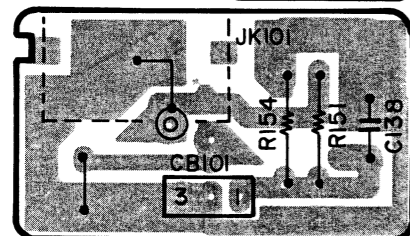
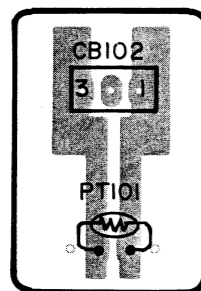

1 2 3 4 5 6 7 8

1U-2910 CONTROL P.W.B. UNIT ASS'Y

A

B

C

D

E

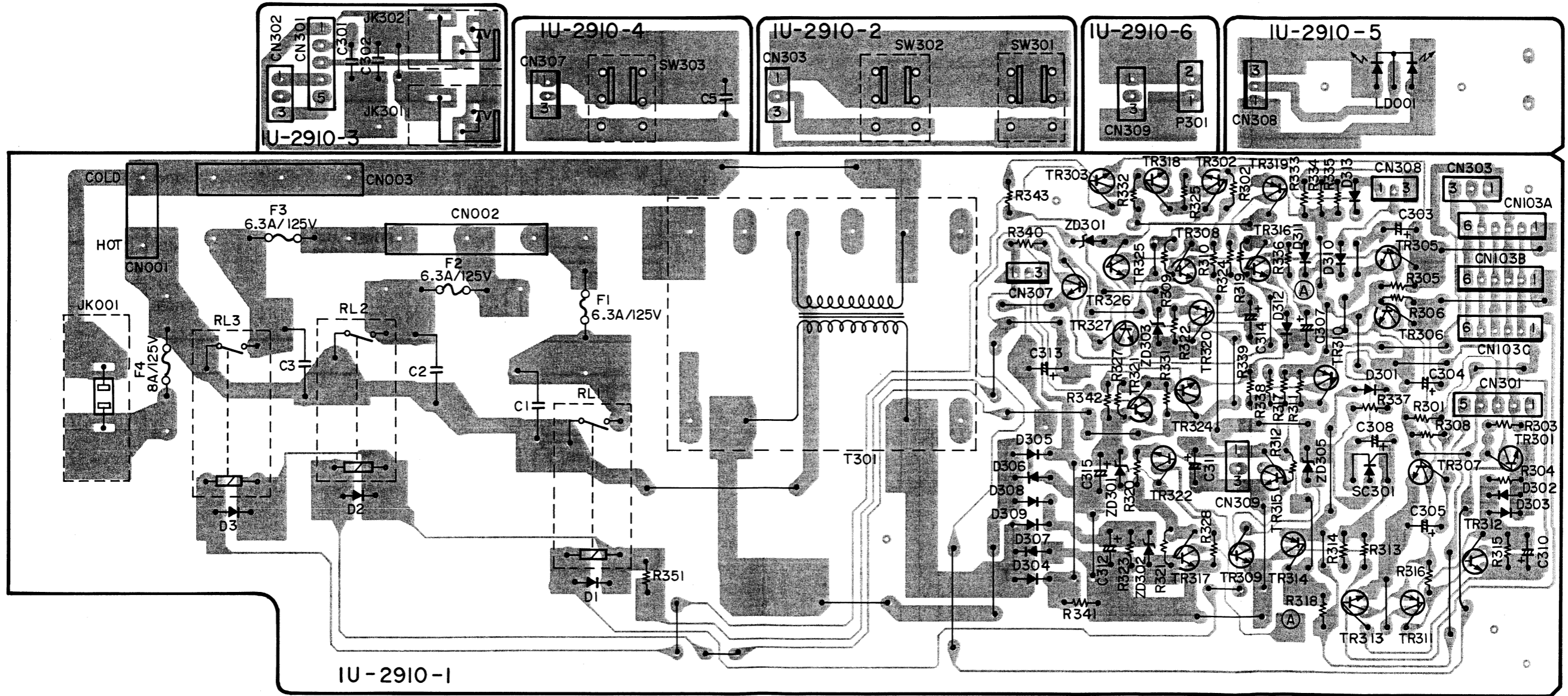

IU-2910-1

WIRING DIAGRAM

